

CEN/TC 98/WG 3 N 39

containing results of meeting
2017-03-01+02
2016-01-14

~~CEN/TC 9898~~

Date: ~~20102010_0808~~

~~EN 1493:2010EN 1493:2010~~

~~CEN/TC 9898~~

Secretariat: ~~DINDIN~~

Vehicle lifts — — Vehiele lifts — —

Fahrzeug-Hebebühnen — — Fahrzeug Hebebühnen — —

Elévateurs de véhicules — — Elévateurs de véhicules — —

ICS: ▲

Descriptors: ▲

Document type: European Standard
Document subtype:
Document stage: Publication
Document language: E

[G:\Dezernat\1. Fachbereich Handel und Logistik\Hebebuehnen_671.4\TC 98\WG 3\EN 1493 - Revision 2015\EN 1493 New Template 2016\EN 1493_E_tr Mannheim 2016-01-14.docx](#)
[G:\Users\sbc\Documents\Umgewandelte Dateien\docx\DIN EN 1493\EN_1493_E_tr.docx](#) STD
Version 2.3a STD Version 2.3a

Formatiert: Schriftartfarbe: Blau

Formatiert: Schriftartfarbe: Blau

Formatiert: Schriftart: 11 Pt., Nicht Fett, Schriftartfarbe: Blau

Formatiert: Schriftart: 11 Pt., Nicht Fett, Schriftartfarbe: Blau

Formatiert: Schriftartfarbe: Blau, Rechtschreibung und Grammatik prüfen

Formatiert: Schriftart: 11 Pt., Nicht Fett, Schriftartfarbe: Blau, Rechtschreibung und Grammatik prüfen

Formatiert: Schriftart: 11 Pt., Nicht Fett, Schriftartfarbe: Blau, Rechtschreibung und Grammatik prüfen

Formatiert: Schriftart: 11 Pt., Nicht Fett, Schriftartfarbe: Blau, Englisch (Großbritannien)

Formatiert: Schriftart: 15 Pt., Schriftartfarbe: Blau, Deutsch (Deutschland), Rechtschreibung und Grammatik prüfen

Formatiert: Schriftart: Kursiv, Schriftartfarbe: Blau, Deutsch (Deutschland), Rechtschreibung und Grammatik prüfen

Formatiert: Schriftart: Kursiv, Schriftartfarbe: Blau, Rechtschreibung und Grammatik prüfen

Feldfunktion geändert

Feldfunktion geändert

Feldfunktion geändert

Formatiert: Deutsch (Deutschland), Rechtschreibung und Grammatik prüfen

Contents

Page

Foreword.....	4
Introduction	5
1 Scope.....	6
2 Normative references.....	6
3 Terms and definitions	7
4 List of hazards	10
5 Safety requirements and/or measures	14
5.1 General.....	14
5.2 Preventing unauthorised operation.....	14
5.3 Control devices.....	14
5.4 Control positions.....	15
5.5 Duplicated drive systems	16
5.6 Speeds.....	16
5.7 Structural design of the supporting structure	17
5.8 Driving machinery.....	26
5.9 Load carrying devices.....	28
5.10 Additional requirements for lifts with balconies	31
5.11 Limiting the travel of the load carrying device	31
5.12 Unintended blocking of the load carrying device.....	32
5.13 Safety against rupture of mechanical bearing devices	32
5.14 Safety against leakage	32
5.15 Additional requirements for lifts with several drives or lifting elements	33
5.16 Additional requirements for movable and mobile lifts.....	34
5.17 Protection against pinching and shearing	34
5.18 Safety devices	36
5.19 Protection against damage	36
5.20 Manually driven vehicle lifts.....	37
5.21 Electrical equipment.....	37
5.22 Special requirements for vehicle lifts where it is permitted to stand under the load during lifting and lowering movement	38
6 Verification of the safety requirements and/or measures	38
6.1 General.....	38
7 Information for use	41
7.1 General.....	41
7.2 Marking.....	41
7.3 Operation instructions.....	42
7.4 Name plate.....	43
Annex A (informative) Structural calculations.....	44
A.1 Permissible stresses.....	44
Annex B (informative) Examples of solutions.....	49
Annex C (normative) Design of rope drives.....	55

Annex D (informative) Example of information about wind	57
Annex E (normative) Protection against leakage	58
Annex F (normative) Additional requirements for cableless controls and control systems	61
F.1 Introduction	61
F.2 General	61
F.3 Control limitation	61
F.4 Stop	61
F.5 Serial data communication	61
F.6 Use of more than one operator control station	63
F.7 Battery-powered operator control stations	64
F.8 Wireless control components	64
Annex G (normative) Noise	65
Annex ZA (informative) Relationship between this European Standard and the Essential Requirements of EU Directive 2006/42/EC	66
Bibliography	67

Foreword

This document (EN 1493:2010) has been prepared by Technical Committee CEN/TC 98 "Lifting platforms", the secretariat of which is held by DIN.

This European Standard shall be given the status of a national standard, either by publication of an identical text or by endorsement, at the latest by **February 2011**, and conflicting national standards shall be withdrawn at the latest by **February 2011**.

Attention is drawn to the possibility that some of the elements of this document may be the subject of patent rights. CEN [and/or CENELEC] shall not be held responsible for identifying any or all such patent rights.

This document supersedes EN 1493:1998+A1:2008.

This document has been prepared under a mandate given to CEN by the European Commission and the European Free Trade Association, and supports essential requirements of **EU Directive(s)**.

For relationship with **EU Directive(s)**, see informative Annex **ZA**, which is an integral part of this document.

According to the CEN/CENELEC Internal Regulations, the national standards organizations of the following countries are bound to implement this European Standard: Austria, Belgium, Bulgaria, Croatia, Cyprus, Czech Republic, Denmark, Estonia, Finland, France, Germany, Greece, Hungary, Iceland, Ireland, Italy, Latvia, Lithuania, Luxembourg, Malta, Netherlands, Norway, Poland, Portugal, Romania, Slovakia, Slovenia, Spain, Sweden, Switzerland and the United Kingdom.

Introduction

This document is a type C standard as stated in EN ISO 12100-1:2003.

The machinery concerned and the extent to which hazards, hazardous situations and hazardous events are covered are indicated in the scope of this document. In addition, machinery should comply as appropriate with EN ISO 12100-1 for hazards which are not covered by this standard.

When provisions of this type C standard are different from those which are stated in type A or B standards, the provisions of this type C standard take precedence over the provisions of the other standards, for machines that have been designed and built according to the provisions of this type C standard.

The object of this European Standard is to define rules for safeguarding persons against the risk of accidents associated with the operation of vehicle lifts.

While elaborating this standard it was assumed that only authorized persons operate the vehicle lifts and that the working area is sufficiently lit.

The requirement concerning loading control is not deemed pertinent to this standard insofar as:

- experience and the state of the art suggests that failing to observe this requirement has not historically given rise to unsafe situations;
- such devices which would give protection against overall and local overloading are not currently available in forms which cover all eventualities;
- the weight and weight distribution is freely available for the type of vehicles to be lifted and as such it is the responsibility of the user to prevent an unsafe situation arising;
- vehicle lifts are generally designed to suit the maximum weight of vehicle to which it would reasonably be subjected, hence the normal duty of a lift is substantially lower than the maximum.

EN 1493:2010 (E)

1 Scope

This European Standard applies to stationary, mobile and movable vehicle lifts, which are not intended to lift persons but which are designed to raise vehicles totally, for the purpose of examining and working on or under the vehicles whilst in a raised position. The vehicle lift may consist of one or more lifting-units.

Power supply to the vehicle lift by internal combustion engines is not considered.

The floor or ground supporting the vehicle lift in use is assumed to be horizontal.

This document is applicable to vehicle lifts which are manufactured ½ year after the date of its publication as EN.

2 Normative references

The following referenced documents are indispensable for the application of this document. For dated references, only the edition cited applies. For undated references, the latest edition of the referenced document (including any amendments) applies.

EN 982:1996+A1:2008, *Safety of machinery — Safety requirements for fluid power systems and their components — Hydraulics*

EN 983:1996+A1:2008, *Safety of machinery — Safety requirements for fluid power systems and their components — Pneumatics*

EN 60204-1:2006, *Safety of machinery — Electrical equipment of machines — Part 1: General requirements (IEC 60204-1:2005, modified)*

EN 60204-32:2008, *Safety of machinery — Electrical equipment of machines — Part 32: Requirements for hoisting machines (IEC 60204-32:2008)*

EN 60529:1991, *Degrees of protection provided by enclosures (IP Code) (IEC 60529:1989)*

EN 60947-5-1:2004, *Low-voltage switchgear and controlgear — Part 5-1: Control circuit devices and switching elements — Electromechanical control circuit devices (IEC 60947-5-1:2003)*

EN ISO 12100-1:2003, *Safety of machinery — Basic concepts, general principles for design — Part 1: Basic terminology, methodology (ISO 12100-1:2003)*

EN ISO 12100-2:2003, *Safety of machinery — Basic concepts, general principles for design — Part 2: Technical principles (ISO 12100-2:2003)*

EN ISO 13849-1:2008, *Safety of machinery — Safety-related parts of control systems — Part 1: General principles for design (ISO 13849-1:2006)*

EN ISO 13849-2:2008, *Safety of machinery — Safety-related parts of control systems — Part 2: Validation (ISO 13849-2:2003)*

EN ISO 13850:2008, *Safety of machinery — Emergency stop — Principles for design (ISO 13850:2006)*

ISO 4308-1:2003, *Cranes and lifting appliances — Selection of wire ropes — Part 1: General*

3 Terms and definitions

For the purposes of this document, the terms and definitions given in EN ISO 12100-1:2003 and the following apply.

3.1

vehicle lift

lifting device with guided load carrying device for lifting land based means of transport such as cars, motorcycles, lorries, buses, trams, rail vehicles, industrial trucks and similar, in the following named vehicle, and designed for working on or under the load

NOTE 1 The guidance of the load carrying device is given by the supporting structure.

NOTE 2 A vehicle lift may have the ability to tilt the load carrying device about a horizontal axis parallel to or perpendicular to the main axis of the lifted vehicle.

NOTE 3 The following types of vehicle lift are examples of those covered by this definition: single and multi-column lifts, single and multi-cylinder lifts, mobile column lifts, scissor and parallelogram lifts, short stroke lifts, which support vehicle wheels, chassis or other designated lifting points (see Annex B (informative)).

NOTE 4 Short stroke lifts are floor mounted vehicle lifts with a maximum vertical travel of not more than 500 mm, which are not designed for working under the raised load.

3.2

manually driven vehicle lift

vehicle lift where the load carrying device is driven by manual effort

3.3

power-driven vehicle lift

vehicle lift where the load carrying device is not driven by manual effort

3.4

fixed vehicle lift

vehicle lift fixed permanently to its location

3.5

movable vehicle lift

vehicle lift which can fulfil its function without being fixed to the floor and may be designed to be transportable

3.6

mobile vehicle lift

movable vehicle lift equipped with wheels, rollers, etc. such that it can be moved from one place to another with or without load

3.6.1

manually mobile vehicle lift

mobile vehicle lift which is moved by manual effort alone

3.6.2

vehicle lift with powered mobility

mobile vehicle lift which is not moved by manual effort

EN 1493:2010 (E)

3.7

initial position

lower limit position of the carrying device

3.8

rated load

maximum load that a lift has been designed to carry referring to the normative vehicle or to special vehicles mentioned in 5.7.4.4

3.9

load carrying device

part(s) of the vehicle lift which supports the load either by direct contact with the vehicle or through contact with pick-up plates or pads

EXAMPLE Tracks, carrying arms or other mechanical devices designed to raise and support a vehicle by designated lifting points.

3.10

carrying arm

load carrying device attached at one end, directly or indirectly to the lifting element and supporting the load at its other end

NOTE Carrying arms are usually used on two column lifts.

3.11

pick-up plate

part of the load carrying device, e.g. on two column lifts with carrying arms, which has direct contact to the vehicle and which has an assigned position on the load carrying device

NOTE See Figure 1.

3.12

pick-up pad

vehicle supporting pad which has direct contact with the vehicle but which does not have an assigned position, e.g. pads used on wheel free systems with platforms

NOTE See Figure 2.

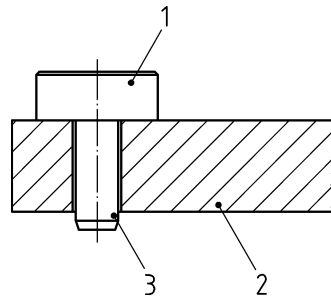

- Key**
- 1 pick-up plate
 - 2 load carrying device
 - 3 pin

Figure 1 — Pick-up plate

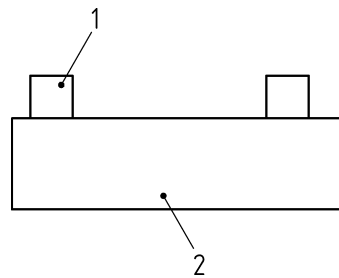

- Key**
- 1 pick-up pad
 - 2 platform

Figure 2 — Pick-up pad

3.13

lifting element

medium through which the force is transmitted from the power source to the load carrying device

NOTE Lifting elements include hydraulic and pneumatic cylinders, lead screw and nut systems as well as any flexible connections such as steel wire ropes and chains.

3.14

catching device

device which holds the load carrying device in case of failure of the lifting element

3.15

re-raising prevention device

device which prevents re-raising of load carrying device from the initial position in the event of failure of the lifting element

3.16

unauthorised use

use by a person who has not received permission to operate the lift and instruction on its safe operation

EN 1493:2010 (E)

3.17 braking

3.17.1 automatic brake

braking device which is normally held on and which is released only by application of power

NOTE Operation is also instigated automatically by releasing the lift controls and by interruption of the power supply.

3.17.2 self braking system

system which, due to its inherent resistance to movement, stops the movement of the load carrying device when the drive power is interrupted

3.18 safety switch

switch in which the opening contacts are directly connected to the control mechanism without springs or flexible elements

NOTE The whole of the specified opening of the contacts should be achieved by operation of the control mechanism through its intended travel using the force stated by the manufacturer of the switch (see K.2.1 of EN 60947-5-1:2004).

3.19 normative vehicle

road vehicle used for calculations in 5.7

3.20 wheel track

distance between the centre lines of the wheels on one axle or between centre lines of wheel pairs on twin wheel axles

3.21 wheel base

distance between the centres of wheels of front and rear axle or from the centre of the wheels on the front axle to a point mid way between axle pairs on twin axle vehicles

3.22 multiple lifting units

combination of independent couples of mobile column lifts or two or more vehicle lifts

3.23 wheel free system

lifting unit which is used in conjunction with a pit or vehicle lift with platform lifting the whole vehicle and allows the wheels to be removed

4 List of hazards

Table 1 contains a list of hazards which are applicable in the situations described and could involve risks to persons if not reduced or eliminated. The corresponding requirements are designed to limit the risk or reduce these hazards in each situation.

"Not applicable" in Table 1 means that this hazard does not exist on vehicle lifts.

"Not significant" in Table 1 means that this hazard can exist on vehicle lifts, but it causes no risk to persons.

Table 1 — List of hazards

Hazards		Corresponding Requirement
1	Mechanical hazards	5.7, 5.9, 5.17.1, 5.22
1.1	Crushing hazards	5.3.1, 5.6.1, 5.6.2, 5.17
1.2	Shearing hazard	5.3.1, 5.6.1, 5.6.2, 5.17
1.3	Cutting or severing hazard	5.8.3.3, 5.18
1.4	Entanglement hazard	5.4.3
1.5	Drawing-in or trapping hazard	5.4.4
1.6	Impact hazard	5.5, 5.8.3.1, 5.8.3.2, 5.11, 5.12, 5.13, 5.14
1.7	Stabbing or puncture hazard	not applicable
1.8	Friction or abrasion hazard	not applicable
1.9	High pressure fluid injection hazard	5.8.4.2, 5.8.4.4, 5.19.3
1.10	Ejection of parts (of machinery and processed materials/work pieces)	not applicable
1.11	Loss of stability (of machinery and machine parts)	5.7.6
1.12	Slip, trip and fall hazards in relationship with machinery (because of their mechanical nature)	5.10
2	Electrical hazards	
2.1	Electrical contact direct or indirect	5.21.1, 5.21.3
2.2	Electrostatic phenomena	not applicable
2.3	Thermal radiation or other phenomena such as ejection of molten particles, and chemical effects from short-circuits, overloads etc.	not applicable
2.4	External influences on electrical equipment	5.21.1
3	Thermal hazards resulting in:	
3.1	Burns and scalds, by a possible contact of persons, by flames or explosions and also by the radiation of heat sources	not applicable
3.2	Health damaging effects by hot or cold work environment	not applicable
4	Hazards generated by noise	
4.1	Hearing losses (deafness), other physiological disorders (e.g. loss of balance, loss of awareness, etc.)	see Annex G

Hazards		Corresponding Requirement
4.2	Interferences with speech communication, acoustic signals, etc.	not applicable
5	Hazards generated by vibration (resulting in a variety of neurological and vascular disorders)	not applicable
6	Hazards generated by radiation, especially by:	
6.1	Electrical arcs	not applicable
6.2	Lasers	not significant
6.3	Ionising radiation sources	not applicable
6.4	Machines making use of high frequency electromagnetic fields	not applicable
7	Hazards generated by materials and substances processed, used or exhausted by machinery	
7.1	Hazards resulting from contact with or inhalation of harmful fluids, gases, mists, fumes and dust	5.8.4
7.2	Fire or explosion hazard	not applicable
7.3	Biological and microbiological (viral or bacterial) hazards	not applicable
8	Hazards generated by neglecting ergonomic principles in machine design (mismatch of machinery with human characteristics and abilities) caused for example by:	
8.1	Unhealthy postures or excessive efforts	5.16.5, 5.20
8.2	Inadequate consideration of human hand-arm or foot-leg anatomy	5.4.1
8.3	Neglected use of personal protection equipment	not applicable
8.4	Inadequate area lighting	not applicable
8.5	Mental overload or underload, stress, etc.	not applicable
8.6	Human error	5.2, 5.3.1, 5.3.2, 5.3.3, 5.3.4, 5.3.5
9	Hazards combinations	
10	Hazards caused by failure of energy supply, breaking down of machinery parts and other functional disorders	
10.1	Failure of energy supply (of energy and/or control circuits).	5.8.4.5, 5.8.4.6, 5.8.4.7, 5.8.5.5, 5.8.5.6, 5.8.5.7, 5.14
10.2	Unexpected ejection of machine parts or fluids	5.8.4.3, 5.8.4.8, 5.8.5.2, 5.8.5.3, 5.8.5.4
10.3	Failure/disorder of control system (unexpected start up, unexpected overrun)	5.3.1, 5.8.1
10.4	Errors of fitting	7.3.1

Hazards		Corresponding Requirement
10.5	Overturn, unexpected loss of machine stability	5.7.6
11	Hazards caused by (temporary) missing and/or incorrect positioned safety related measures/means	
11.1	All kinds of guard	5.10, 5.17.3
11.2	All kinds of safety related (protection) devices	5.7.5.1, 5.17.3, 5.18
11.3	Starting and stopping devices	5.8.2
11.4	Safety signs and tags	5.3.4
11.5	All kinds of information or warning devices	7.2, 7.3
11.6	Energy supply disconnecting devices	5.21.1, 5.21.2, 5.21.3
11.7	Emergency devices	5.4.5
11.8	Feeding/removal means of work pieces	not applicable
11.9	Essential equipment and accessories for safe adjusting and/or maintaining	7.3
11.10	Equipment evacuating gases, etc.	not applicable
HAZARDS DUE TO MOBILITY		
12	Inadequate lighting of moving/working area	5.4.1, 5.4.3
13	Hazards due to sudden movement, instability etc. during handling	5.16.1, 5.16.2
14	Inadequate/inergonomic design of driving/operating position	5.4.1
14.1	Hazards due to dangerous environments (contact with moving parts, exhaust gases, etc.)	not applicable
14.2	Inadequate visibility from driver's/operator's position	not applicable
14.3	Inadequate seat/seating (seat index point)	not applicable
14.4	Inadequate/inergonomic design/positioning of controls	5.4.1
14.5	Starting/moving of self-propelled machinery	5.16.1, 5.16.2
14.6	Road traffic of self-propelled machinery	not applicable
14.7	Movement of pedestrian controlled machinery	5.16.3
15	Mechanical hazards	
15.1	Hazards to exposed persons due to uncontrolled movement	5.16.1
15.2	Hazards due to break-up and/or ejection of parts	not applicable
15.3	Hazards due to rolling over (deflection limiting volume; DVL)	not applicable
15.4	Hazards due to falling objects	not applicable 5.22

Hazards		Corresponding Requirement
15.5	Inadequate means of access	5.10
15.6	Hazards caused due to towing, coupling, connecting, transmission etc.	not applicable
15.7	Hazards due to batteries, fire, emissions, etc.	5.21.3, 5.21.4
HAZARDS DUE TO LIFTING OPERATION		
16.1	Lack of stability	5.7
16.2	Derailment of machinery	5.16.4
16.3	Loss of mechanical strength of machinery and lifting accessories	5.7.5
16.4	Hazards caused by uncontrolled movement	5.8.1, 5.8.2, 5.4.5
16.5	Hazards due to falling loads	5.9.3, 5.9.5, 5.13, 7.3.1
17	Inadequate view of trajectories of the moving parts	5.4.3
18	Hazards caused by lighting	not applicable
19	Hazards due to loading/overloading	5.8.4.2, 5.8.5.3

5 Safety requirements and/or measures

5.1 General

Machinery shall comply with the safety requirements and/or protective measures of this clause. In addition, the machine shall be designed according to the principles of EN ISO 12100 (all parts) for relevant but not significant hazards, which are not dealt with by this document.

5.2 Preventing unauthorised operation

Vehicle lifts shall be equipped with an accessible and fixed device that prevents unauthorized use after taking the lift out of operation (refer to Annex B (informative)).

5.3 Control devices

5.3.1 Hold-to-run control

Control devices shall be of the hold-to-run type and shall fulfil the conditions of performance level c of EN ISO 13849-1:2008. The stop-function shall comply with category 0 of 9.2.2 of EN 60204-1:2006.

5.3.2 Grouped control devices

If the control devices for more than one vehicle lift are grouped together in one position each control device shall be clearly marked to show which vehicle lift it controls.

5.3.3 Logical operation

The control devices shall be designed so that the movement of the control and its location are consistent with its effect (refer to Annex B (informative)).

5.3.4 Marking

The direction of the movement of the lifting element shall be permanently marked (refer to Annex B (informative)). The marks shall be suitable symbols or text and can be located on the control devices themselves or directly adjacent to them.

5.3.5 Inadvertent operation

Control devices shall be protected from unintentional operation (refer to Annex B (informative)).

5.4 Control positions

5.4.1 Layout

Control devices shall be designed and arranged so that they are within easy reach of a standing operator, and so that the operator is not jeopardised by the load or the motion of the lift or of parts of the lift.

Where it is possible to control the lift from more than one control station, there shall be measures to enable only one control stations at one time.

~~Remote control (wireless or wired) shall only be used if there exists an additional release switch at the vehicle lift which has to be pushed when using the remote control. This additional switch shall be located so that the person pushing it has a direct view to the load to be lifted/lowered.~~

~~The additional release switch is not necessary if the remote control system will only operate within a defined standing area which gives the operator a direct view to the load to be lifted/lowered (e.g. short cable, infrared control system).~~

Remote control systems (wireless or wired) are only allowed if they only operate within a defined standing area which gives the operator a direct view to the load to be lifted/lowered (e.g. short cable, infrared control system). If this requirement (direct view) cannot be fulfilled, other safety measures are necessary (see Annex B). If the position of the operator can be under the load, the requirements of 5.22 shall be fulfilled in addition.

When more than one vehicle lift is installed in the workshop, all wireless controls shall be individually paired to the lift they operate. The pairing process shall be conducted by the operator and shall expire every 15 minutes.

Wireless control systems shall conform to Annex F (normative).

5.4.2 Visibility

The control position to operate the vehicle lift shall be designed and arranged, so that the operator can watch the load carrying device and the load whilst in motion, as well as the space under the load carrying device and the load. This applies to the operation of both multiple and single lifting devices.

If the vehicle lift is intended to be used so that the hazardous area cannot be completely viewed from the operating position (the use of tools like mirrors or cameras/monitors is acceptable), e.g. vehicle lifts

EN 1493:2010 (E)

for rail-bound vehicles, one or more additional release switch(es) approving the commands for the lifting movements (on the side of the lifting system positioned across from the control position) are required.

NOTE This needs negotiation between user and manufacturer respectively supplier of the vehicle lift.

In addition if the vehicle lift is mobile the operator shall be able to observe the space especially in moving direction of the vehicle lift.

5.4.3 Controlling several load carrying devices

If the load carrying devices of a vehicle lift are intended to be moved independently, a selection control shall be provided that enables:

- a) the independent movement of each load carrying device; and
- b) movements of all load carrying devices together.

Other combinations of movements of the load carrying devices may also be incorporated and selected by the selection control.

The non-selected load carrying devices shall be prevented from operating.

5.4.4 Emergency stop device

At a column lift for rail-bound vehicles, each column shall be equipped with an emergency stopping device which fulfils the requirements of EN ISO 13850:2008 and stops the movements of all columns. The emergency stop device shall comply with performance level d of EN ISO 13849-1:2008.

The main switch can act as an emergency stop (refer to 5.3.3 and 10.7.4 of EN 60204-1:2006).

Activation of any of the emergency stops shall stop the motion of all the lifting devices. The stop-function shall comply with category 0 of 9.2.2 of EN 60204-1:2006.

5.4.5 Stopping device

Each control position shall be equipped with a device to stop all movements of the vehicle lift. This device shall have priority over the start controls and be able to stop the movements also in case of one failure as mentioned in EN ISO 13849-2:2008.

5.5 Duplicated drive systems

Drive systems which are both motor driven and manually driven shall be designed in such a way that neither drive can put the other drive into motion.

5.6 Speeds

5.6.1 Lifting and lowering speed

The speed for lifting and lowering shall not exceed 0,015 m/s for vehicle lifts for rail-bound vehicles (trains, trams, etc.) and 0,15 m/s for other vehicle lifts.

5.6.2 Tilting speed

The speed of tilting, measured at the part of the load carrying device which is furthest away from the turning centre, shall not exceed 0,1 m/s.

5.7 Structural design of the supporting structure

5.7.1 General

The design of vehicle lifts in relation to materials, construction and equipment shall be such that a satisfactory level of safety is achieved under all operating conditions including the failure situations described in this standard. This shall be demonstrated by calculation. Use of the permissible stress method is allowable.

The stress, resulting from the most unfavourable load distribution, shall be calculated for each load bearing part. For permissible stresses refer to Annex A (informative). The values of Annex A are given under the condition of 22 000 load cycles at rated load. If this value is exceeded, fatigue calculation shall be performed for structure and mechanism. In case of exceptional situation (e.g. during activation of a safety device in case of emergency or during static load test) the yield stress divided by a safety factor of 1,1 is acceptable.

Wheel support vehicle lifts for road vehicles shall be designed in such a way that during normal operation the maximum inclination of the platform in its longitudinal axes is limited to 1°.

5.7.2 Loads and forces

5.7.2.1 Regular loads

a) Structural loads

The masses of components of the vehicle lift produce the structural loads.

- 1) Loads due to components which are not moving are considered to be static structural loads.
- 2) Loads due to moving components are considered to be dynamic structural loads.

b) Rated load

c) Dynamic forces

Dynamic forces are due to working movements such as raising, lowering and tipping in service. These shall be taken into account by multiplying the moved structural loads and the payload by the dynamic factor ϕ , which shall be calculated in relation to the nominal speed v in metres per second. An alternative to this is to take ϕ equals to 1,151 since the factor $0,34v$ is of the order 0,051 maximum.

$$\phi = 1,1 + 0,34v$$

d) Manual forces

Manual force is produced by operators. This force shall be taken as 1 000 N acting horizontally at the height of the supporting point. For motor bike lifts this force shall be 10 % of the rated load, but not less than 300 N.

e) Effects of accessories

EN 1493:2010 (E)

Effects of accessories for the vehicle lift, e.g. jacking beams, of a type approved by the manufacturer for use on that lift.

f) Effects of inclination

Influence of permissible inclination.

Manual forces and dynamic forces do not act simultaneously and shall not be combined. Manual forces and static forces shall be combined.

5.7.2.2 Occasional loads – In-service wind

If the vehicle lift is designed for outside use, the influence of wind forces in the wheel base direction shall be included in the stress calculation (see also 5.7.3) and overturning calculation (see also 5.7.6).

The maximum pressure of in-service wind is 125 N/m², which is related to a wind speed of 14 m/s (50,4 km/h).

The wind forces acting on the normative vehicle (refer to Table 4) shall be derived from Table 2.

Table 2 — Wind forces and stabilising effects

Rated load t	Wind force F_W kN		Stabilising weight effect [kN] and exposed surface [m ²]	Axle wind force ratio		
	in service	out-of- service		F_1/F_W	F_2/F_W	F_3/F_W
a) $P \leq 2,5$	0,75	3	6	0,40	0,60	/
b) $2,5 < P \leq 3,5$	1	4	8	0,40	0,60	/
c) $3,5 < P \leq 7,5$	1,875	7,5	15	0,33	0,66	/
d) $7,5 < P \leq 20$	2,25	9	18	0,33	0,66	/
e) $20 < P \leq 30$	2,625	10,5	21	0,33	0,66	/
f) $30 < P \leq 40$	3	12	24	0,45	0,55	/
g) $P \leq 25$	5,25	21	42	0,25	0,30	0,45
h) $P \leq 40$	4,875	19,5	39	0,20	0,30	0,50
i) $40 < P \leq 52$	5,25	21	42	0,20	0,30	0,50
j) $P \leq 40$	4,125	16,5	33	0,17	0,33	/
k) $40 < P \leq 52$	4,875	19,5	39	0,17	0,33	/
l) $P \leq 45$	4,875	19,5	39	0,20	0,40	0,40

5.7.2.3 Exceptional loads

a) Out-of-service wind

If the vehicle lift is designed for outside use the influence of wind forces in the wheel base direction shall be included in the stress calculation (see also 5.7.3).

The maximum pressure of out-of-service wind is 500 N/m^2 , which is related to a wind speed of 28 m/s.

The wind forces acting on the normative vehicle (refer to Table 4) shall be derived from Table 2.

It is assumed that in any case the operator lowers the raised vehicle in the nearest position to the ground level at the end of his working time. A corresponding requirement shall be written in the operation instructions if the vehicle lift is designed for outside use.

For the overturning stability calculation a stabilising weight effect of 1 kN for each square metre of exposed vehicle surface to the wind can be considered as stabilising moment (refer to Table 2).

b) Action

- 1) of the catching device; or
- 2) of the re-raising prevention device.

c) Test load for:

- 1) dynamic test (see 6.1.5.2);
- 2) static test (see 6.1.5.3).

5.7.3 Load combinations

The loads defined in 5.7.2 shall be combined and classified as indicated in Table 3.

Table 3 — Load combinations

Load	Clause	Load combination						
		A1	A2	B1	B2	C1	C2	C3
Regular loads	5.7.2.1							
Structural loads – static	a1	1	1	1	1	1	1	1
Structural loads – dynamic	a2	ϕ	1	ϕ	1	1	1	1
Rated load	b	ϕ	1	ϕ	1	1	1	1
Manual forces	d	-	1	-	1	-	-	-
Effect of accessories	e	ϕ	1	ϕ	1	1	1	1
Effect of inclination	f	ϕ	1	ϕ	1	1	1	1
Occasional loads - In-service wind	5.7.2.2	-	-	1	1	-	-	-
Exceptional loads	5.7.2.3							
Out-of-service wind	a	-	-	-	-	1	-	-
Action of the catching device	b1	-	-	-	-	-	1	-
Action of the re-raising prevention device	b2	-	-	-	-	-	-	1

EN 1493:2010 (E)

Load combination A1:	Normal operation (raising/lowering) without wind or special forces
Load combination A2:	Normal operation (service/repair work) without wind or special forces
Load combination B1:	Normal operation (raising/lowering) with wind force
Load combination B2:	Normal operation (service/repair work) with wind force
Load combination C1:	Vehicle lift out of service with wind force
Load combination C2:	Action of the catching device
Load combination C3:	Action of the re-raising prevention device

ϕ : Multiplication factor according to 5.7.2.1.

5.7.4 Load distribution

5.7.4.1 General

The following requirements shall be fulfilled if no special data are specified by the customer. The rated load shall be distributed on the four corners of a rectangle with the width equating to wheel track and the length to wheel base.

5.7.4.2 Wheel support vehicle lift for road vehicles

The rated load shall be distributed according to normative vehicle dimensions as shown in Table 4.

When carrying out structural design in accordance with the data given in Table 4 consideration shall be given in each case to normative vehicles both less than and equal to the rated load to ensure that the most adverse loading situations are considered.

For structural design purposes vehicle positioning on load carrying devices shall be considered in both directions.

The vehicle track symmetry axis and the wheel supports symmetry axis are coincidental.



For all normative vehicles with more than two axles, the 2- or 3-axle combinations shall be considered as a single "virtual" axle.

The minimum distance X between the nearest vehicle axle and the wheel support end depends on the type of normative vehicle (dimension, single-, double-, triple-axle) (refer to Table 4).

When calculating for tracks, the plate stresses caused by supporting the loads shall be taken into account assuming that the load is uniformly distributed on a square or circular area at a pressure of 50 N/cm². In the case of a virtual axle the force to be considered for calculating plate stresses shall be equally distributed on each axle. Plate stresses need not be considered if the plain area between any two flanges or supporting sections is not considered when calculating the supporting cross section.

Structural design shall consider the vehicle driving on and off wheel supports.

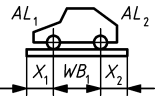
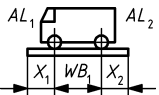
Table 4 — Normative vehicle

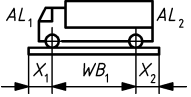
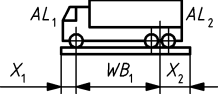
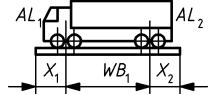
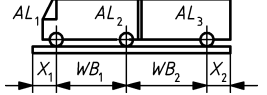
I-tem	Rated load t	Type of vehicle	No. of axles	Normative vehicle	Wheel track WT m	Wheel base m			Axle load ratios			Min. distance m	
						WB 1	WB 2	WB 3	AL ₁ / P	AL ₂ / P	AL ₃ / P	X ₁	X ₂
a	$P \leq 2,5$	Passenger cars	2		1,5	2,5	-	-	0,40	0,60	-	0,3	0,3
b	$2,5 < P \leq 3,5$	Commerci al light truck	2		1,6	3	-	-	0,40	0,60	-	0,3	0,3
c	$3,5 < P \leq 7,5$	Commerci al medium trucks	2		1,7	3	-	-	0,33	0,66	-	0,3	0,3
d	$7,5 < P \leq 20$	Lorries	2/3		1,8	3,5	-	-	0,33	0,66	-	0,5	0,5
e	$20 < P \leq 30$	Lorries	3		1,9	4	-	-	0,33	0,66	-	0,5	1
f	$30 < P \leq 40$	Lorries	4		1,9	4,5	-	-	0,45	0,55	-	1	1
g	$P \leq 25$	Articulate d busses	3		1,8	5,5	6,5	-	0,25	0,30	0,45	0,5	0,5

EN 1493:2010 (E)

I-tem	Rated load t	Type of vehicle	No. of axles	Normative vehicle	Wheel track WT m	Wheel base m			Axle load ratios			Min. distance m	
						WB 1	WB 2	WB 3	AL ₁ /P	AL ₂ /P	AL ₃ /P	X ₁	X ₂
h	$P \leq 40$	Articulate d lorries	4		1,9	3,5	7	-	0,20	0,30	0,50	0,5	1
i	$40 < P \leq 52$	Articulate d lorries	≥ 5		1,9	3,5	7	-	0,20	0,30	0,50	0,5	1,6
j	$P \leq 40$	Lorries with trailer	4		1,9	3,5	3	3,5	0,17	0,33	-	0,5	0,5
k	$40 < P \leq 52$	Lorries with trailer	≥ 5		1,9	4,	3	4	0,17	0,33	-	0,5	1
l	$P \leq 45$	Lorries with trailer	≥ 5		1,9	4	5	-	0,20	0,40	0,40	0,5	1

Feldfunktion geändert

5.7.4.3 Chassis supporting vehicle lift for road vehicles

The load rectangle wheel track symmetry axis and the lift wheel track symmetry axis are coincidental.

Pick-up plates and their shafts shall be designed to suit the load acting at a point half way between the centre and the outside edge of the pad.

a) Rated load $\leq 3,5$ t

For rated loads $\leq 3,5$ t the load ratios between the front and rear load carrying points shall be (in both —directions):

2 : 3 and 3 : 2 (maximum load one pick-up point $\frac{3}{10}$ of P)

On platform lifts the rated load shall be distributed on the four corners of a rectangle with the dimensions of:

- 100 cm (width) \times 140 cm (length); and
- 170 cm (width) \times 140 cm (length)

at the maximum length of the platform and at the worst condition (with the maximum load at the corner of —the platform or platform extension).

On vehicle lifts with carrying arms the rated load shall be distributed on the four corners of a rectangle —with the dimensions of 100 cm (width) with the maximum load at the maximum length of the longest arm —and the short arm in the position which gives the worst condition reaching the load rectangle.

b) Rated load $> 3,5$ t

For rated loads $> 3,5$ t the load ratios between the front and rear load carrying points shall be (in both —directions):

1 : 3 and 3 : 1 (maximum load one pick-up point $\frac{3}{8}$ P)

On platform lifts the rated load shall be distributed on the four corners of a rectangle ~~ular~~ with the dimensions of:

- 100 cm (width) \times 180 cm (length); and
- 170 cm (width) \times 180 cm (length)

at the maximum length of the platform and at the worst condition (with the maximum load at the corner of —the platform or platform extension).

On vehicle lifts with carrying arms the rated load shall be distributed on the four corners of a rectangle —with the dimensions of 100 cm (width) with the maximum load at the maximum length of the longest arm —and the short arm in the position which gives the worst condition reaching the load rectangle.

EN 1493:2010 (E)

5.7.4.4 Special vehicle lifts (lifts for forklift trucks, dumpers, rail-bound vehicles, etc.)

Where the prescriptions of 5.7.4.2 and 5.7.4.3 cannot be applied:

- a) the load distribution shall be in accordance with the axle loadings of the vehicles which are to be lifted. If the lift is intended for use with different models of vehicle, the distribution shall suit the most unfavourable model;
- b) all lifts which are designed for load distributions other than those in 5.7.4.2 and 5.7.4.3 shall be equipped with clearly understood load distribution plates and load plates respectively (on mobile column lifts) of sufficient size and placed in conspicuous locations.

5.7.5 Lifting elements

5.7.5.1 Catching devices and mechanical re-raising prevention devices

In case of response of catching devices or re-raising prevention devices no permanent deformations shall occur in any part required for continued normal operation.

If permanent deformation occurs in a safety device, exact instructions shall be given in the operation manual with regard to the measures to be taken (e.g. replacement of the part, removal of burrs).

5.7.5.2 Rope drives

Steel wire ropes for rope drives shall comprise a minimum of 114 single wires. The nominal tensile grade of each wire shall be at least 1 570 N/mm² but not exceed 1 960 N/mm².

The tensile grade of terminations shall be a minimum of 80 % of that of the rope.

For the terminations of wire ropes the following shall be used:

- splices;
- aluminium press ferrules;
- non-ageing steel press ferrules;
- wedge socket anchorages.

The minimum breaking force of the wire ropes shall be shown on a certificate.

Wire rope, drum and pulley diameters shall be calculated according to ISO 4308-1:2003 using the classification of mechanism M5 or higher. Ropes used for synchronization shall be calculated using the classification of mechanism M3 or higher.

As an alternative wire rope, drum and pulley diameters can be calculated according to Annex C (normative).

5.7.5.3 Chain drives

The minimum breaking load of chains shall be at least four times the maximum possible static load, with the rated load in the most unfavourable position. Proof of minimum braking load shall be provided in the form of a manufacturer's certificate.

Chain wheels and sprockets with undercut teeth shall not be used.

The tensile strength of terminations shall be a minimum of 80 % of that of the chain.

5.7.5.4 Hydraulic and pneumatic drives

Hydraulic and pneumatic cylinders, pipes and their connections which may be subjected to the maximum pressure permitted by the pressure relief valve shall be designed to withstand at least:

- two times this pressure in hydraulic drives;
- three times this pressure in pneumatic drives

without permanent deformation.

Hoses, air bags and bellows shall be dimensioned in order to withstand a bursting pressure equal to at least three times the maximum pressure permitted by the pressure relief valve.

5.7.5.5 Screw-drives

The lead screw mechanism shall be designed to prevent separation of the load supporting device from the mechanism during normal use.

Each spindle shall be fitted with a load bearing nut and an unloaded safety nut or other constantly active safety device. The safety nut shall only be loaded if the load bearing nut fails.

Screw-drives using recirculating ball systems may use a catching device according to 5.13.1 instead of safety nuts.

Lead screws shall be fitted with devices at both ends to prevent the load bearing and safety nuts from leaving the threaded portion of the lead screws.

The lead screw material shall have a higher abrasion resistance than the load bearing nut material. For drives using recirculating ball systems other criteria for the materials involved are valid.

5.7.5.6 Mechanical connections of several lifting elements

If a mechanical synchronization device is used to control the height of lifting elements, this device, including the mechanical elements, shall be able to withstand the worst load differences that can or will be possible between the lifting elements including failure of lifting elements, hydraulic leakage, etc.

5.7.6 Proof of stability against overturning

Lifts which are not anchored to the ground are considered stable if the stabilising moments, M_s are greater than the tilting moments, M_t multiplied by a safety factor. If the vehicle weight acts to stabilise the lift then a stabilising weight can be considered in the calculation. The stabilising weight effect of each type of normative vehicle is shown in Table 2. All load combinations enumerated in 5.7.3 shall be investigated with forces acting in their most unfavourable direction. The following conditions shall be fulfilled:

- *Case A:* $1,3 \times M_t \leq M_s$
- *Case B:* $1,2 \times M_t \leq M_s$

EN 1493:2010 (E)

— *Case C*: $1,1 \times M_t \leq M_s$

NOTE The same criteria apply by using fixing bolts to fix the vehicle lift on the floor.

5.8 Driving machinery

5.8.1 Preventing inadvertent motion

Vehicle lifts shall be provided with an automatic device which prevents inadvertent motion of the load carrying device and which operates above the first 500 mm of vertical travel of the load carrying device from the initial position (refer to Annex B (informative)). Vehicle lifts designed to be used over pits or as wheel free systems shall fulfil this requirement throughout the travel of the load carrying device.

Where brakes are used to fulfil this requirement, compression springs shall provide the brake action (see 5.18.5). The springs shall be adequately supported and shall not be stressed in excess of 80 % of the torsional elastic limit of the material.

Band brakes shall not be used.

Brake linings shall be of incombustible material (excluding asbestos) and shall be fixed such that normal wear does not weaken the fixings.

Brakes shall be provided with means of adjustment.

Brake blocks and linings shall be protected against ingress of lubricants, water, dust or other contaminants.

5.8.2 Holding devices

Where lifts are designed for people to stand under the vehicle and load carrying devices, the lifting elements operating those carrying devices, or the carrying devices themselves, shall be held automatically in their inoperative position by self-locking means (refer to Annex B (informative)).

5.8.3 Additional requirements for mechanical drives

5.8.3.1 Derailment protection

Pulleys and wheels for ropes and chains shall be provided with derailment protection. This shall be designed such that the rope or chain cannot pass between the derailment protection and the pulley or wheel.

5.8.3.2 Safety at nip points

Safeguards shall be provided to prevent access to wire rope and chain nip points.

When it is foreseen (e.g. maintenance) that fixed guards will be removed regularly then the fastenings shall remain attached to the guards or to the vehicle lift.

5.8.3.3 Tension regulation

If more than one rope or chain are acting at one point it shall be possible to regulate their tension.

5.8.4 Additional requirements for hydraulic drives

5.8.4.1 General

The requirements of EN 982:1996+A1:2008 shall be fulfilled.

5.8.4.2 Pressure relief valve

The hydraulic system shall be provided with a pressure relief valve. If different maximum pressures are used in separate circuits of the hydraulic system, then one pressure relief valve shall be provided for each circuit. The pressure relief valve shall be the first valve in any circuit. The adjustment of the pressure relief valve shall only be possible by means of tools and protection shall be provided which prevents unauthorized adjustment.

Pressure relief valves shall be adjusted to act at a pressure which is not more than 10 % above that produced when operating with the rated load.

5.8.4.3 Bleeding

It shall be possible to bleed the hydraulic system.

5.8.4.4 Connection for pressure gauge

In all hydraulic systems there shall be a connection for a pressure gauge at an accessible location.

5.8.4.5 Filter

In all hydraulic systems there shall be a device that filters the hydraulic fluid. In fluid tanks there shall be a device that filters the incoming air.

5.8.4.6 Fluid level control

Hydraulic tanks shall be provided with means of indicating the actual level and the minimum permissible fluid level.

5.8.4.7 Size of the fluid tank

Fluid tanks shall be of sufficient size such that their capacity exceeds the displaced volume of the related lifting system by at least 10 %.

NOTE "Lifting system" means all the hydraulic cylinders.

5.8.4.8 Gas loaded accumulator

If a gas loaded accumulator creates the necessary pressure for the hydraulic bearing device, the motion shall automatically stop as soon as the allowable minimum liquid level in the tank is reached.

5.8.5 Additional requirements for pneumatic drives

5.8.5.1 Introduction

The requirements of EN 983:1996+A1:2008 shall be fulfilled.

EN 1493:2010 (E)

5.8.5.2 General

If the vertical travel of the load carrying device is greater than 500 mm then the vehicle lift shall be fitted with an automatic mechanical interlocking and holding device. Note this is in order to restrict the hazard of unintended motion of the load carrying device (refer to Annex B (informative)). Vehicle lifts designed to be used over pits or as a wheel free system shall fulfil this requirement throughout the travel of the load carrying device.

5.8.5.3 Pressure relief valve

The pneumatic system shall be provided with a pressure relief valve. The non return valve shall be located between the pressure relief valve and the cylinder.

If different maximum pressures are used in separate circuits of the pneumatic system, then one pressure relief valve shall be provided for each circuit. The pressure relief valve shall be the first valve in any circuit. The adjustment of the pressure relief valve shall only be possible by means of tools and protection shall be provided which prevents unauthorised adjustment.

5.8.5.4 Pressure reduction

If the pressure created by the pressure generator is greater than the adjusted pressure of the pressure relief valve, a device shall be installed that will automatically reduce the generated pressure (refer to Annex B (informative)).

5.8.5.5 Hot working

Pneumatic lifts with air bags and bellows as lifting element which are intended to be used in connection with hot works (welding, grinding, etc.) shall have protection against damage, for example by covering the bellow.

5.8.5.6 Use in low temperatures

Vehicle lifts which are intended to be used at a temperature below + 10 °C shall be designed so that ice formation in the pneumatic system is prevented, for example by the metering of spirits.

5.8.5.7 Moisture reduction

The pneumatic system shall be equipped with a moisture reduction device.

5.9 Load carrying devices

5.9.1 Unintended motion of the load carrying device

Load carrying devices shall be designed in order to prevent swinging, inadvertent tilting, rotating or shifting.

5.9.2 Vehicle pick-up-plates

Pick-up-plates and pad extensions shall engage with the basic carrying member so as to prevent it from overturning when subject to a horizontal force of $H = 1\,000\text{ N}$, applied in the most unfavourable direction, when the lift is loaded with the rated load. The centre of gravity of the vertical load shall be considered to act on the pick-up-plate at 50 % eccentricity and the plate adjusted to the maximum height (see Figures 3 and 4). In the case of pad extensions only one shall be used at each lifting point.

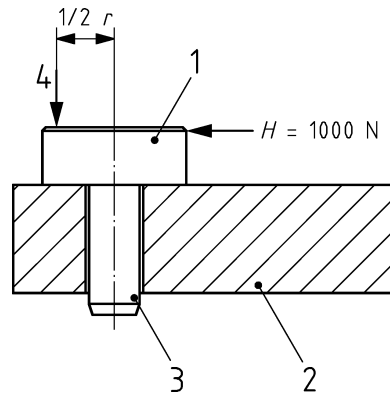

Key

- 1 pick-up plate
- 2 load carrying part
- 3 pin
- 4 vertical load
- H horizontal force
- r radius of the pick-up plate

Figure 3 — Pick-up plates

Vertically adjustable pick-up plates with threaded spindles shall be self-braking and shall be prevented from unscrewing (see Figure 4).

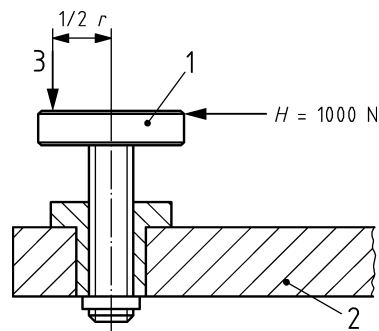

Key

- 1 pick-up plate
- 2 load carrying part
- 3 vertical load
- H horizontal force
- r radius of the pick-up plate

Figure 4 — Adjustable pick-up plates

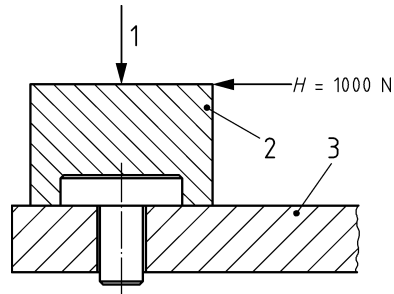

Key

- 1 1/3 of the rated load
- 2 pad extension
- 3 load carrying part
- H horizontal force

Figure 5 — Pad extension

5.9.3 Vehicle pick-up pads

If pick-up pads are used on the carrying device of the lift, the following requirements shall be observed:

- a) Pick-up pads shall be prevented from sliding, for example with an interlocking or friction surface between the pick-up pad and the carrying device of the lift. This system shall be capable of withstanding a horizontal force of $H = 1\ 000\ \text{N}$, applied in the most unfavourable position and condition (e.g. oil between pad and carrying device), and with the lift loaded with $1/3$ of the rated load, without giving rise to movement of the pad.
- b) The pick-up pads shall be conical or cubic in order to assure a safe and clear use. The maximum ratio between height of the pad and the diameter of the largest circle which could be inscribed in the base of the pick-up pad shall not exceed 1:1.

5.9.4 Securing devices on vehicle lifts where the load carrying devices can tilt

Where vehicle lifts allow tilting of the load carrying device, a mechanical securing device shall be provided which positively locks the vehicle to the load carrying device.

5.9.5 Locking systems of carrying arms

Carrying arms shall be equipped with automatic mechanical locking systems that prevent the arms from swinging inadvertently and which operate, regardless of load, above the first 300 mm of vertical travel. Vehicle lifts designed to be used over pits or as a wheel free system shall fulfil this requirement throughout the travel of the load carrying device.

If this locking system operates in discrete steps, the step increment at the end of a fully extended arm shall not be greater than the diameter of the pick-up plate.

It shall not be possible to fix the arm locks in a disengaged condition above 300 mm of travel.

Arm locking systems shall be designed to resist a force of 4,5 % of the capacity of the lift without permanent deformation, or to resist a force of 6,75 % of the capacity without breakage. The forces used however shall not be less than 1 500 N and 2 250 N respectively. Forces are assumed to act horizontally at the load carrying points, and in the most unfavourable direction, with the arms fully extended.

5.9.6 Roll-off safety device

Each track shall have end stops at both ends to prevent vehicles from rolling off. The stop shall automatically raise into position after a vertical travel of the tracks of 0,75 m, or they shall be securely fixed in position. The height of stops shall be at least 0,1 m above the surface of the track.

Roll-off safety devices for rail vehicles shall have a minimum height of 25 mm above the track and shall automatically come into operation after a vertical travel of the tracks of 0,1 m.

Each end stop shall be designed to resist a horizontal force of 20 % of the rated load, applied to the top, without permanent deformation or to resist a force of 30 % of the rated load without breakage.

5.10 Additional requirements for lifts with balconies

Vehicle lifts with integrated accompanying or stationary elevated front or side balconies higher than 1 m above the ground shall be equipped with means to prevent people falling from the balconies.

The means of prevention shall, as a minimum, consist of rigid guard-rails at least 1,1 m high, rigid toe guards at least 0,15 m high and rigid intermediate guard-rails not further than 0,5 m from either guard-rail or toe guards.

Movable parts of the means of prevention shall be securable against unintended motion during their operation. Swinging or tilting parts shall be inward opening.

When it is foreseen (e.g. maintenance) that the fixed guard rails will be removed regularly then the fastenings shall remain attached to the guards or to the machine.

Protection devices are not necessary in the following cases:

- a) around the normal openings required for working under the vehicle;
- b) at stationary balconies on the sides facing the carrying device.

The surface of elevated front and/or side balconies shall be non-slip. Holes, spaces or piercings in the balcony surface shall be no larger than would allow a sphere of 0,02 m diameter to pass through.

For the prevention of trapping between moving parts refer to 5.17.3.

5.11 Limiting the travel of the load carrying device

Before the load carrying device reaches its extreme end positions its motion shall be stopped.

Hydraulic or pneumatic cylinders which directly carry the load carrying device shall have a mechanical stop or an overflow which limits the lifting height.

Vehicle lifts using hydraulic or pneumatic cylinders in which the load carrier is completely or partly carried by ropes or chains without incorporating a mechanical stop at the cylinder shall limit the lifting height by switching off the corresponding control circuit.

EN 1493:2010 (E)

For mechanically driven vehicle lifts devices shall be provided which switch off the corresponding control circuit at the normal limits of the raising and lowering movement.

Mechanically driven vehicle lifts shall also be provided with mechanical stops or safety switches at both extremes of travel to give additional safety in the event of failure of the normal limit devices. Failure of the upper normal limit device and/or actuation of a safety switch shall result in the lowering of the load being permitted but subsequent re-raising from the initial position prevented.

5.12 Unintended blocking of the load carrying device

To prevent unacceptable slack or free play, vehicle lifts in which the lowering motion of a load carrying device is achieved by gravitational force and not directly driven downwards by permanently fixing to the drive force, shall be equipped such that the drive power is cut, and the motion of all the carrying devices is stopped. Motion in the opposite direction shall still be possible (refer to Annex B (informative)).

5.13 Safety against rupture of mechanical bearing devices

5.13.1 Safety catch

Vehicle lifts in which the load carrying devices are held by ropes or chains, and vehicle lifts with mechanical lifting elements shall be designed to prevent the load carrying devices from lowering more than 100 mm in case of rupture of rope, chain, carrying nut or gear. This shall be operational at any stationary position after a vertical travel of the load carrying device of 500 mm as well as during the lifting and lowering cycles. A safety device shall be operated in this event which automatically stops the motion. Vehicle lifts designed to be used over pits or as a wheel free system shall fulfil this requirement throughout the travel of the load carrying device (refer to Annex B (informative)).

The safety catch shall be independent of the drive system and not be dependent on energising or maintaining an electrical or other auxiliary circuit.

5.13.2 Unloaded accompanying bearing devices

As an alternative to a safety catch according to 5.13.1 ropes, chains, carrying nuts or gears which accompany the normal lifting elements and which are unloaded during normal operation can be used. In the case of failure of the normal lifting element it can be possible to lower the load, but restarting the lifting operation from the initial position shall be prevented.

5.14 Safety against leakage

5.14.1 Limiting the lowering speed

Vehicle lifts with hydraulic or pneumatic drives shall be designed to prevent the load carrying device from lowering faster than 1,5 times the normal lowering speed in the case of leakage in the line.

5.14.2 Protection against leakage

Vehicle lifts shall be designed to prevent the load carrying device from moving more than 100 mm from any position in case of leakage after a vertical travel of the load carrying device of 500 mm. Vehicle lifts designed to be used over pits or as a wheel free system shall fulfil this requirement throughout the travel of the load carrying device (refer to Annex B (informative)). Depending on the type of vehicle lift the solutions described in Annex E (normative) to fulfil this requirement are accepted.

Any safety device used to achieve this may be released in order to lift or lower the carrying device, but shall automatically resume its function after an intentional stop.

If two or more mechanically connected cylinders are carrying the same load and are independently equipped with non-return valves, each cylinder shall be designed to carry the total load without permanent deformation.

5.15 Additional requirements for lifts with several drives or lifting elements

If vehicle lifts are designed to carry the load on several drives or lifting elements, it shall be assured that:

- a) the separate lifting platforms respectively lifting elements are not overloaded when carrying the intended load;

NOTE 1 When placing the load, load differences between separate lifting units or lifting elements may occur due to unsymmetries of the load.

- b) carried loads cannot roll, slide, tilt or rotate;
- c) unintentional desynchronisation is limited within the following constraints (see 5.4.3 and Annex B (informative)):

- 1) a difference of 50 mm or 1° of tilt in case the difference is more than 50 mm;
- 2) an additional 100 mm difference in case of blockage of the lifted load, rupture of the driving or control unit, leakage in the hydraulic or pneumatic line, of rupture of ropes, chains, nuts or gears;
- 3) with vehicles having a high torsional rigidity (e.g. rail vehicles) overloading of the lifting system can already occur within the limits mentioned under 1) and 2). Measures shall be taken to prevent overload including the additional desynchronisation caused by the function of safety devices (e.g. overdimensioning or load-limiting device). The correct placing of the load shall be monitored during start up as well as during lifting and lowering (load sensing and/or levelling device).

NOTE 2 For vehicle lifts mentioned in 3) special attention (negotiation between user and manufacturer) should be given to the maximum values described in 1) and 2).

The safety concept of the system (e.g. electrical control system of lifting platforms) shall, as a general, comply with performance level c of EN ISO 13849-1:2008.

Safety related parts of control systems for vehicle lifts mentioned under c) shall comply with performance level d of EN ISO 13849-1:2008.

In case of failure measures shall be provided to ensure restoration of orderly conditions. The correct procedure in case of a stop due to an "out of limits" synchronisation system shall be provided within the complete operation instructions.

EN 1493:2010 (E)

5.16 Additional requirements for movable and mobile lifts

5.16.1 Safety against unintended motion

It shall be possible to prevent mobile or movable vehicle lifts from moving inadvertently on level floors and those which slope within the limits stated by the lift manufacturer (refer to Annex B (informative)).

Brakes used to fulfil this requirement shall be dimensioned such that they will prevent spontaneous movement of a vehicle lift at rest and loaded with the rated load, on a slope 2° greater than stated as acceptable by the manufacturer.

5.16.2 Service brakes for vehicle lifts using powered mobility

Vehicle lifts which use powered mobility shall be equipped with automatic brakes.

The brakes shall be dimensioned such that they can stop an unloaded vehicle lift running at the maximum speed stated by the manufacturer and on a slope 2° greater than stated as acceptable by the manufacturer.

5.16.3 Devices for moving manually mobile lifts

Suitable hand grips shall be provided on manually mobile lifts where the frame does not afford adequate gripping. Grips shall be designed to prevent hand injury and shall be positioned so that their use does not produce a hazard of foot trapping around the frame or wheels of the vehicle lift during movement of the vehicle lift.

5.16.4 Derailment protection

If a vehicle lift is moved on rails, derailment shall be prevented.

5.16.5 Forces

The manual forces at an ambient temperature of (20 ± 5) °C shall not exceed 400 N to start the movement and 300 N to sustain the movement on a flat level floor.

5.17 Protection against pinching and shearing

5.17.1 General

Pinching and shearing points shall be made safe by means of sufficient distance between the moving parts or between the moving and stationary parts. If this is not possible other means shall be used so that neither the operator nor bystanders are jeopardised.

Persons standing next to a lift are considered protected from pinching and shearing points between the carrying device and the ground if coverage is afforded by the vehicle being lifted.

5.17.2 Safety distances

As a minimum the following parts of the human body shall be safeguarded by these minimum distances:

- width of fingers: 25 mm;
- height of feet: 120 mm.

The pinching and shearing points for feet are considered as avoided if a minimum free space for feet is maintained in accordance with Figure 6.

Dimensions in millimetres

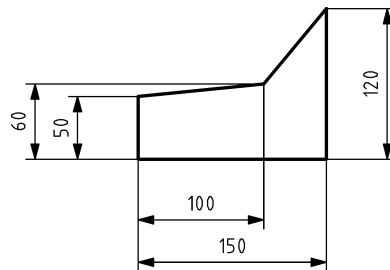

Figure 6 — Clearance for feet

Exceptions are permitted for drive on ramps which are mounted in such a way that the vertical squeezing forces are restricted to not more than 250 N.

5.17.3 Other safety measures

For places where the specified distances cannot be observed, devices such as covers or rails shall be used to prevent access to the dangerous areas or other devices shall be used which stop the movement of the lift if an object or part of the body is placed in its path. In all cases these devices shall not give rise to any additional hazards.

Covers or rails may be constructed from rigid or flexible materials. Rigid materials shall be dimensioned so as to withstand any load to which they are likely to be subjected without permanent deformation. Flexible materials shall be robust enough not to be damaged during their use.

Devices which stop the movement of the lift (e.g. pressure sensitive edges/bars according to EN 1760-2:2001+A1:2009) shall do so before a dangerous situation arises.

The requirement for protection of feet is also satisfied if, during the lowering of the lift, the movement is automatically halted at a distance of 120 mm before the dangerous position. The movement may then be restarted by operation of an additional lowering control or by releasing and reactivating the normal lowering control. This final portion of the travel shall be accompanied by an audible warning. In either case it shall not be possible to override the stopping device such that the lift travels to its initial position without stopping.

For wheel free systems the requirement for protection against pinching and shearing is satisfied:

- if there exists a safety distance of at least 25 mm between the scissor arms when operating the controls for lowering an acoustic signal is automatically activated which sounds during the whole lowering movement;
- if there exists no safety distance between the scissor arms when operating the controls for lowering an acoustic signal is automatically activated two seconds before the movement starts and continues throughout the whole of the lowering movement.

EN 1493:2010 (E)

When it is foreseen (e.g. maintenance) that the fixed guards will be removed regularly then the fastenings shall remain attached to the guards or to the vehicle lift.

5.18 Safety devices

5.18.1 Introduction

Safety devices for vehicle lifts are emergency stop devices (see 5.4.4), devices to prevent inadvertent motion (see 5.8.1), pressure relief valves (see 5.8.4.2 and 5.8.5.3), arm locking systems (see 5.9.5), roll-off safety devices (see 5.9.6), safety catches (see 5.13.1), unloaded accompanying bearing devices (see 5.13.2), safety means in the event of hose and pipe damage (see 5.14), means to prevent pinching and shearing (see 5.17.3), safety switches (see 5.18.4).

5.18.2 General

Safety devices shall be designed and arranged so that they are protected against unauthorised or inadvertent adjustment or damage.

5.18.3 Function of safety devices

Mechanical safety devices shall operate by using mechanically interlocking parts and not rely on friction.

5.18.4 Safety switches

Safety switches shall fulfil the requirements of EN 60947-5-1:2004.

Safety switches in lifts are, for example, switches that will stop the drive in the event of inadvertent blocking of the carrying devices, or switches in switch-off elements that protect pinching and shearing points. In this instance only the current motion shall be stopped, and the reverse motion may be still obtainable.

Safety switches which control failure are, for example, emergency limit switches, wire rope, chain, nut, or gear rupture switches, or levelling control switches. After being operated, those switches shall prevent normal further operation of the lift (refer to Annex B (informative)).

Safety switches shall operate such that safety devices are activated by cutting off the power.

5.18.5 Springs in safety devices

Failure of a spring shall not make safety devices inoperative (refer to Annex B (informative)). Furthermore, compression springs shall be guided to prevent them buckling or the ends becoming displaced during use.

5.19 Protection against damage

5.19.1 Wearing parts

It shall be possible to inspect wire ropes, chains and screws over their whole length without difficulty for maintenance and examination. Thread wear on the lifting nut shall be measurable without difficulty, for example, by careful measurement of the distance between the lifting nut and the unloaded safety nut. If necessary, inspection holes shall be provided.

5.19.2 Lead screws

Lead screws in screw drives shall be protected from damage and dirt.

5.19.3 Installation of hoses, pipes and electrical equipment

Hoses, pipes and electrical equipment shall be installed such that they will not be damaged during the movement of loads or part of the machinery.

5.20 Manually driven vehicle lifts

Control mechanisms of manually driven vehicle lifts shall be equipped in such a way that:

- a) winding handles, levers or wheel cannot turn back under load more than 15 cm, measured at the greatest radius of the control (reversal security). Reversal security shall not be necessary for hand-wheels if these take the form of complete smooth disc wheels imperforate and without any other handles;
- b) the direction of rotation of winding handles remains the same regardless of gearing; and
- c) removable winding handles, levers, and hand wheels shall be secured against slipping and unintentional removal from the drive shaft (refer to Annex B (informative)).

The driving force on the provided handle measured at the end of it at the rated load at an ambient temperature of (20 ± 5) °C shall not exceed 400 N when driven according to the manufacturer's specification.

5.21 Electrical equipment

5.21.1 General

All parts of electrical equipment shall meet the requirements of the relevant CENELEC-Standards, especially EN 60204-1:2006.

5.21.2 IP-code

The IP-code according to EN 60529:1991 shall be at least IP 54. Components in systems less than 48 V do not need to meet this specification if disconnection or malfunction does not lead to an unsafe situation.

5.21.3 Means of disconnecting the power supply

Vehicle lifts with electrical drives shall be equipped with a device that allows the power supply to be disconnected (see EN 60204-1:2006). Deviating from 5.3.3 of EN 60204-1:2006 a switch with two On-positions which control the up and down movement can be used if it fulfils all other requirements on a main switch according to EN 60204-1:2006.

5.21.4 Batteries

Batteries shall be secured in position and be protected against external effects such as vibrations, water, high pressure cleaning, etc.

EN 1493:2010 (E)

5.22 Special requirements for vehicle lifts where it is permitted to stand under the load during lifting and lowering movement

5.22.1 Control devices

To avoid unintentional movements in case of one failure, the control circuits for lifting and lowering movement as well as the emergency stop function shall comply with performance level d of EN ISO 13849-1:2008. All relevant failures listed in EN ISO 13849-2:2008 shall be considered.

5.22.2 Control positions

Control positions shall be located in a way that persons standing under the vehicle are in a direct field of vision of the operator at the control devices. A direct speech communication shall be possible. If necessary, an additional control position shall be provided. If remote control is activated all other controls shall be deactivated.

If the vehicle lift is fitted with a remote control (wired or wireless) which can be used from a position under the load a release switch at a fixed position outside of the hazardous area shall be provided. From the position of the switch the operator shall have a direct view to the person under the load. The release switch shall be of the hold-to-run type.

5.22.3 Lifting and lowering speed

The maximum speed for lifting and lowering shall not exceed 5 mm/s.

5.22.4 Safety against rupture or leakage of load bearing devices

Vehicle lifts shall be equipped with facilities preventing unintentional lowering of more than 20 mm in case of rupture of ropes, chains, carrying nuts or gears or leakage in the hydraulic or pneumatic system. These facilities shall be effective during lifting and lowering movement as well as at the standstill of the raised load.

5.22.5 Operation instructions

The operation procedure in case of a person is standing below moving loads shall be described precisely in the operation instructions. At least two persons are required for this mode of operation (operator and worker under the load).

6 Verification of the safety requirements and/or measures

6.1 General

6.1.1 Introduction

The tests given in this verification chapter shall be used to verify the compliance of vehicle lifts and their components with this standard. These tests shall be carried out on at least a sample of each model type.

The test to ensure that the vehicle lift complies with this standard shall consist of:

- a) design check (see 6.1.2);

- b) manufacturing check (see 6.1.3);
- c) visual verification (see 6.1.4);
- d) practical tests (see 6.1.5).

The results of examinations and tests, either done by the manufacturer or by a competent body, and the name and address of person(s) and firm making them shall be recorded in a signed report.

6.1.2 Design check

The design check shall verify that the vehicle lift is designed in accordance with this standard. It shall at least be checked that:

- a) drawings contain the main dimensions of the vehicle lift;
- b) there is a description of the vehicle lift with necessary information about its capabilities;
- c) there is information about the material and components used;
- d) there are diagrams of the electrical, hydraulic and pneumatic circuits;
- e) there are instructions covering installation, commissioning, operating, maintenance and dismantling.

The documents shall give all necessary information to enable:

- f) the structural calculations to be checked;
- g) the stability calculations to be checked.

6.1.3 Manufacturing check

The manufacturing check shall verify that:

- a) the vehicle lift is manufactured in accordance with the checked documents, with special attention to safety devices;
- b) the test certificates are available for ropes, chains and hoses;
- c) welding has been performed according to the drawings.

6.1.4 Visual verification

It shall be verified that:

- a) all markings defined in 7.2, 7.3.2 and 7.4 are attached to the vehicle lift;
- b) the vehicle lift is in accordance with all documentation provided by the manufacturer.

EN 1493:2010 (E)

6.1.5 Practical tests

6.1.5.1 General

Practical tests shall be made to verify that:

- a) the vehicle lift is stable;
- b) the vehicle lift is structurally sound;
- c) all functions work correctly and safely.

6.1.5.2 Overload dynamic test

The test load shall be 115 % of the rated load.

The load distribution shall be made in accordance with 5.7.4.

All movements with the test load shall be carried out at accelerations and decelerations appropriate with safe control of the load. The intended movements shall be carried out with care taking into due account the least favourable positions and when vibrations associated with preceding movements have subsided.

When, due to various combinations of load distributions of a vehicle lift, tests with different test loads are necessary, all movements shall be carried out with all test loads except where the least favourable conditions can be simulated by one performance test. During this test the vehicle lift shall be capable of stopping and sustaining the test load(s).

6.1.5.3 Overload static test

The test load shall be 150 % of the rated load.

During this overload static test the vehicle lift shall be put into each position which creates maximum stress in any load carrying part of the lift.

After removing the test load(s) the vehicle lift shall show no permanent deformation.

6.1.5.4 Functional tests

a) With rated load

Functional tests with rated load shall demonstrate that:

- 1) the vehicle lift can be operated smoothly for all motions at the rated speed;
- 2) the safety devices work correctly. This included the protection against leakage (see 5.14.2), which shall be tested with 40 % and 100 % of the rated load;
- 3) the levelling devices work within stipulated differences (see 5.15);
- 4) maximum permitted speeds are not exceeded.

b) Without load

Functional test without load shall demonstrate that the arm locking system resists the stipulated values (see 5.9.5).

6.1.5.5 Electrical tests

Electrical tests shall be performed according to EN 60204-1:2006.

7 Information for use

7.1 General

Information for use may consist of text, words, signs, signals or diagrams, used separately or in combination. It is directed to the installer and the user.

The information of use is an integral part of the supply of the vehicle lift.

This information shall comply with Clause 6 of EN ISO 12100-2:2003 and with the following provisions.

7.2 Marking

The following information shall be fixed on the lift and shall be readily visible:

- a) the rated load in kilograms or tonnes;
- b) the allowable load distribution if the rated load depends on it;
- c) the unladen weight in kilograms or tonnes if the lift is movable or mobile;
- d) a warning sign "travelling on the load carrying devices is forbidden" if the lift is not designed for this purpose;
- e) hydraulic supply information if an external hydraulic power supply is used;
- f) pneumatic supply information if an external pneumatic power supply is used;
- g) electrical supply information if an external electric power supply is used;
- h) if the vehicle lift is designed for outside use specific information about safe use of the lift when exposed to wind effect, in which the maximum allowed wind speed exposure for each type of normative vehicle is shown (refer to Annex D (informative)).

7.3 Operation instructions

7.3.1 Complete operation instructions

A complete operation manual containing the information for safe use and operation of the lift shall be supplied with each lift.

This manual shall include at least the following information:

- a) range of application (use, misuse);
- b) installation and commissioning;
- c) handling and behaviour while operating the lift;
- d) monitoring of the safety devices;
- e) maintenance;
- f) inspection;
- g) trouble shooting;
- h) replacement of parts, e.g. due to wear or operation of safety devices;
- i) if applicable charging of batteries and ventilation of the room;
- j) the vehicle lift shall be operated with respect to the complete operating instructions;
- k) only authorized persons shall operate the lift;
- l) in the case of multiple lifting units, the rated load of each unit and guidance on safe combined rated loads shall be provided;
- m) in case that persons are permitted to stand under the vehicle during lifting and lowering the following hints:
 - 1) special training has to be given to the operator and the persons which are permitted to stand under the vehicle during lifting and lowering;
 - 2) during normal operation no persons are permitted to stand under the vehicle;
 - 3) persons are only permitted to stand under the moving load in extreme circumstances where movements of the load should be kept as short as possible;
- n) the additional release switch(es), if appropriate, shall be located in such a way that from these locations together with the normal operating position the whole hazardous area can be monitored;
- o) maximum permissible wind speed according to 5.7.2.2 and 5.7.2.3, if appropriate.

In cases b), e) and f) the information shall also include necessary information concerning the strength of foundations and necessary inspection traps in the floor.

In the event of the vehicle lift being first assembled at the user's site, the operation instructions shall contain a statement that it shall be checked that the vehicle lift and the associated safety and protective devices are correctly installed and function in a proper manner. The procedure shall be written in the operation manual.

7.3.2 Digest of the operation instructions

A digest of the operation instructions containing at least the following information taking into account possible hazards existing for the lift where applicable for the safe operation shall be fixed on the lift and shall be readily visible.

- a) The operation of the lift is permitted by authorised persons only.
- b) It is necessary to refer to the complete operation instructions, especially for trouble shooting.
- c) Movable and mobile lifts shall be prevented from moving unintentionally.
- d) The field of motion of the load and of the load carrying devices shall be free of obstructions.
- e) It shall draw attention to the safe method of carrying the load and to the rule that, after raising a short distance, the vehicle shall be checked to ensure that it is correctly and safely positioned.
- f) It shall draw attention to the rule that the load carrying device shall be observed by the operator throughout the motion of the lift.
- g) It is forbidden for people to stand in the field of motion of the load and the load carrying device during the movement, if appropriate.
- h) It is forbidden to climb onto the load or load carrying device when they are raised unless via a specifically designed access.
- i) Maximum permissible wind speed according to 5.7.2.2 and 5.7.2.3, if appropriate.

7.4 Name plate

A durable name plate with following information shall be permanently fixed on the lift (refer to Annex B (informative)) and shall be readily visible:

- a) business name and full address of the manufacturer and, where applicable, his authorised representative;
- b) country of manufacture;
- c) designation of the machinery;
- d) designation of series or type;
- e) serial number;
- f) year of construction, that is the year in which the manufacturing process is completed.

Annex A (informative)

Structural calculations

Feldfunktion geändert

Feldfunktion geändert

Feldfunktion geändert

A.1 Permissible stresses

A.1.1 General

Symbols

$f_y (R_{EH})$	[N/mm ²]	Yield strength
$f_u (R_m)$	[N/mm ²]	Ultimate strength
$E = 210\,000$	[N/mm ²]	Modulus of elasticity
G $= \frac{E}{2 \times (1 + \nu)}$	[N/mm ²]	Shear modulus
$\nu = 0,3$		Poisson's ratio
δ_5	[%]	Elongation at failure on gauge length of five times the diameter of the original cross section
t	[mm]	Nominal thickness

Nominal values of material properties for standardised structural steels (EN 10025-2:2004), see Table A.1.

Table A.1 — Material properties (in N/mm²)

	Nominal thickness of the element			
	$t \leq 40$ mm		40 mm $< t \leq 80$ mm	
	f_y	f_u	f_y	f_u
S 235	235	360	215	360
S 275	275	430	255	410
S 355	355	510	335	470

A.1.2 Standardised structural steels

Permissible stresses

$$\sigma_a = fy/s$$

where

s is the safety factor depending on the load combination A, B or C, as shown in the following Table A.2.

Table A.2 — Permissible stresses (in N/mm²)

Load combination	A $s = 1,5$			B $s = 1,33$			C $s = 1,25$		
	S 235	S 275	S 355	S 235	S 275	S 355	S 235	S 275	S 355
Basic material and butt joint									
$\sigma_a = \sigma_0$	157	183	237	176	206	266	188	220	284
$\tau_a = \sigma_0/\sqrt{3}$	90	106	137	102	119	154	109	127	164
Fillet weld									
$\sigma_a = \sigma_0$	157	183	237	176	206	266	188	220	284
$\tau_a = \sigma_0/\sqrt{2}$	111	130	167	125	146	188	133	156	201

The indicated permissible stresses are valid up to a thickness of 40 mm: in case of greater thickness the corresponding value of fy shall be taken into consideration.

Selecting the materials special requirements shall be taken into account, e.g.:

- weldability;
- use of the appliance in extreme climate zones.

A.1.3 Bolts

a) Bolts

The permissible stresses are derived from X , which is the lower value of fy and $0,7 \times fu$ (see Table A.3).

$$\sigma_a = X/s \qquad \tau_a = \sigma_a/\sqrt{2}$$

Table A.3 — Permissible stresses for bolts (in N/mm²)

Load combination	s	Grade	4.6	5.6	6.6	6.8	8.8	10.9
		f_y	240	300	360	480	640	900
		X	240	300	360	420	560	700
A	1,5	σ_a	160	200	240	280	373	467
		τ_a	113	141	170	198	264	330
B	1,3 3	σ_a	180	225	270	315	420	525
		τ_a	127	159	191	223	297	371
C	1,2 5	σ_a	192	240	288	336	448	560
		τ_a	136	170	204	238	317	396

b) Preloaded bolts

Grade 8.8 and 10.9 only

Symbols A_s [mm²] tensile stress area of bolt F_v [N] preload d [mm] bolt diameter M_t [Nm] tighteningBolts used one time $F_v = 0,8 \times f_y \times A_s$ Bolts used several times $F_v = 0,7 \times 0,8 \times f_y \times A_s$ Tightening $M_t \approx 0,18 \times d \times F_v / 1\ 000$ **c) Bearing pressure**The permissible bearing pressure σ_L depends on the basic material and is not only valid for bolt connections but also for axles (see Table A.4).Articulation $\sigma_L = 1,3 \times \sigma_0$ Clearance joint $\sigma_L = 1,5 \times \sigma_0$ Fitted joint $\sigma_L = 2,0 \times \sigma_0$

Table A.4 — Bearing pressure (in N/mm²)

Load combination	A			B			C		
	S 235	S 275	S 355	S 235	S 275	S 355	S 235	S 275	S 355
Articulation	204	238	308	229	268	346	244	286	369
Clearance joint	235	275	335	264	309	399	282	330	426
Fitted joint	313	367	473	352	412	532	376	440	568

A.1.4 Non-standardised structural steels

Depending on the minimum values of the ultimate strength f_u , the yield strength f_y and the elongation at failure δ_5 an ideal yield strength f_{yi} is to be defined taking into consideration the following conditions:

- a) $f_y \leq 0,7 \times f_u$ $f_{yi} = f_y$
- b) $510 < f_u \leq 590$ $\delta_5 \times f_u \geq 10\ 800$
 $590 < f_u$ $\delta_5 \times f_u \geq 9\ 800$

If this condition is fulfilled, the following applies:

$$f_{yi} = 0,8 \times f_u$$

If this condition is not fulfilled, the following applies:

$$r = \frac{26\ 000 - f_u \times (6 + \delta_5)}{9\ 600}$$

$$1,28 \leq r \leq 1,44$$

$$f_{yi} = f_u / r$$

Based on f_{yi} the permissible stresses shall be calculated with the safety factors s given for general structural steels.

A.1.5 Combined stress

Structural parts and butt joints:

$$\sigma = \sqrt{\sigma_x^2 + \sigma_y^2 - \sigma_x \times \sigma_y + 3 \times \tau^2}$$

Bolts, axles and fillet welds:

$$\sigma = \sqrt{\sigma_x^2 + \sigma_y^2 - \sigma_x \times \sigma_y + 2 \times \tau^2}$$

EN 1493:2010 (E)

A.1.6 Elastic stability

a) Crippling

Symbols

λ = slenderness

λ' = specific slenderness

ω = crippling factor

The crippling factor ω is defined in the following way:

$$\lambda' = \lambda \times \sqrt{fy/E}/\pi$$
$$\begin{array}{ll} 0 < \lambda' \leq 1,195 & \omega = 1/(1 - 0,195 \times \lambda' - 0,185 \times \lambda'^{2,5}) \\ 1,195 < \lambda' \leq 3 & \omega = 1,465 \times \lambda'^2 \end{array}$$

The highest permissible slenderness is $\lambda = 250$.

b) Buckling

The critical buckling stress σ_{vki} is defined in the following way:

$$\begin{array}{ll} \sigma_{vki} < 0,7 \times fy & \sigma_{vk} = \sigma_{vki} \\ \sigma_{vki} \geq 0,7 \times fy & \sigma_{vk} = fy \times \sqrt[4]{1 - 0,461/(\sigma_{vki}/fy)^{1,4}} \end{array}$$

Annex B (informative)

Examples of solutions

Feldfunktion geändert

Feldfunktion geändert

Feldfunktion geändert

This annex predominantly comprises solutions describing methods by which the requirements of the normative text can be fulfilled.

To 3.1

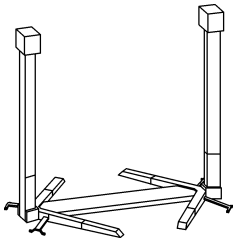

Figure B.1 — Two-column-lift

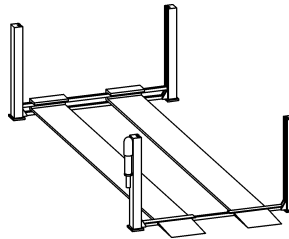

Figure B.2 — Four-column-lift

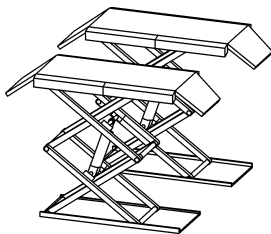

Figure B.3 — Scissor-lift

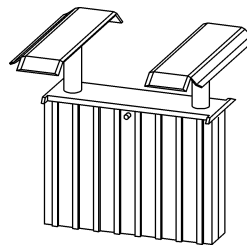

Figure B.4 — Two-cylinder-lift

To 5.2

This requirement can be fulfilled as follows:

- a safety switch with a key that can only be taken out after the lift has stopped; or
- a push-button that locks automatically and can only be released with a security key; or
- an interlockable main switch according to 5.3.2, a), b) or c) of EN 60204-1:2006.

To 5.3.3

For the lifting and lowering operation this requirement can be fulfilled as follows (see Figures B.5 to B.11):

EN 1493:2010 (E)

- a) where buttons are used, if the button for the raising movement is positioned above or to the right of the button for the lowering movement (see Figure B.5);

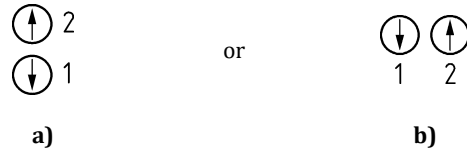

Key

- 1 down
2 up

Figure B.5 — Arrangement of buttons

- b) where foot operated buttons are used, if the button for the raising movement is positioned to the right of the button for the lowering movement (see Figure B.6);

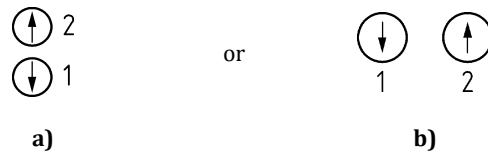

Key

- 1 down
2 up

Figure B.6 — Arrangement of foot operated buttons

- c) where horizontal levers are used:

- 1) if upward movement of the lever generates the raising movement and the downwards movement of the lever generates the lowering movement (see Figure B.7);

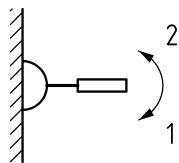

Key

- 1 down
2 up

Figure B.7 — Up and down movement of horizontal levers (side elevation)

- 2) if the movement of the lever to the right generates the raising movement and the movement of the lever to the left generates the lowering movement (see Figure B.8);

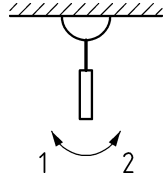

Key

- 1 down
- 2 up

Figure B.8 — Left and right movement of horizontal levers (plan view)

- d) where vertical levers are used, if the movement of the lever towards the human body generates the raising movement and the movement of the lever away from the human body generates the lowering movement (see Figure B.9);

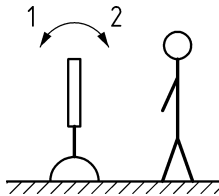

Key

- 1 down
- 2 up

Figure B.9 — Movement of vertical levers

- e) where pedals are used, if the pedal for the raising movement is on the right and for the lowering movement on the left (see Figure B.10);

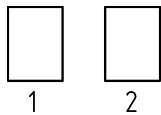

Key

- 1 down
- 2 up

Figure B.10 — Arrangement of pedals

- f) where hand wheels are used, if turning the wheel to the right starts the raising movement and turning it to the left starts the lowering movement (see Figure B.11);

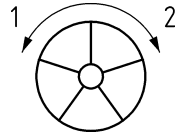

Key

- 1 down
- 2 up

Figure B.11 — Movement of hand wheels

To 5.3.4

The requirement "permanently marked" is e.g. fulfilled, if the following test is passed:

Rubbing the marking by hand for 15 s with a piece of cloth soaked with petroleum spirit. After this test the marking shall be easily legible, it shall not be easily possible to remove marking plates and they shall show no curling.

To 5.3.5

This requirement can be fulfilled as follows:

- a) Push-buttons: The button shall not be larger than is necessary for it to be operated by one finger of a hand wearing a protective glove. A ring shall surround the button, with minimal clearance, and no part of the button shall protrude above the ring.
- b) Foot operated buttons: The space above the button shall be completely covered. The distance between the button and the cover should be approximately 70 mm. A rectangular tubular section approximately 15 mm high should surround the button to protect it from access from the sides (see Figure B.12).

Dimensions in millimetres

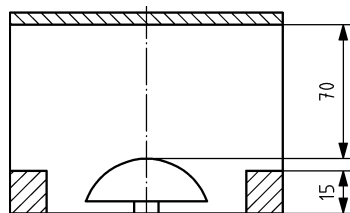

Figure B.12 — Covering of foot operated buttons

- c) Hand levers: The lever should automatically lock in its home position.
- d) Hand wheels: Shall be round, solid and have no burrs or sharp edges.

If it is necessary to use more than one control device simultaneously to operate the lift then it is sufficient if only one of them is protected against unintentional operation.

To 5.4.1

The requirement can be fulfilled by

1. An additional release switch at the vehicle lift which has to be pushed when using the remote control. This additional switch shall be located so that the person pushing it has a direct view to the load to be lifted/lowered.

2. A load sensor on the lift that switches off the remote control when the load is on the lift.

3. Limited lifting height of 300 mm, when using the remote control.

To 5.8.1

Self-braking screws as load carrying device fulfil this requirement. For hydraulically driven lifts, pilot operated non-return valves in the oil supply and oil return lines fulfil this requirement.

To 5.8.2

Examples of self locking means include non-return valves which lock the hydraulic pressure medium in the cylinder, latches and self-braking systems.

To 5.8.5.2

The requirement is fulfilled if, for example, a system consisting of hooks and latches is provided.

To 5.8.5.4

The requirement is fulfilled if for example, a pressure reduction valve is fitted.

To 5.12

The requirement "to cut the drive power" is fulfilled, if the control circuit is cut.

For vehicle lifts where the load carrying devices are suspended on wire ropes or chains, a safety switch should cut off the drive in the event of a slack rope or chain. The same effect is also required for screw driven vehicle lifts and those with hydraulic bearing devices if the load carrying device is not fixed to the load bearing nut or hydraulic cylinder. In this case the lowering movement shall be stopped by means of a switch which detects separation of the load carrying device and the nut or cylinder.

To 5.13.1

The requirement is fulfilled if, for example:

- a mechanical, automatic system consisting of hooks and latches; or
- unloaded accompanying bearing devices according to 5.13.2

is provided.

To 5.14.2

This requirement shall be fulfilled by means of a mechanical locking device consisting of hooks and latches or other systems (e.g. mechanical connectors between cylinders with independently non-return valves) that prevent moving.

It is assumed that not more than one leakage in the circuit is considered at the same time.

Formatiert: Schriftart: 11 Pt.

EN 1493:2010 (E)

To 5.15

The requirement can be fulfilled by use of control systems or by mechanical connecting systems (e.g. chains or cardan shafts).

The requirement also means that chains used for the transmission of power between lift screws should be provided with a slack chain switch or similar device which prevents dangerous desynchronisation of the load carrying devices in the event of a broken or disengaged chain.

To 5.16.1

In the case of mobile vehicle lifts the requirement is fulfilled if there are:

- a) lockable parking brakes on at least two wheels; or
- b) spring loaded wheels in at least two positions so that the loaded lift cannot be moved; or
- c) supports lifting at least two wheels from the ground; or
- d) at least one automatically retractable wheel when the load is applied.

To 5.18.4

The requirement is fulfilled:

- if re-raising from the initial position is prevented in situations where unloaded accompanying bearing devices are fitted according to 5.13.2;
- in all other cases if all motions are stopped.

To 5.18.5

This requirement can be fulfilled by the use of compression springs with both ends fixed or by selection of springs such that the wire diameter is greater than the distance between the coils, hence preventing the two pieces from winding into each other in the event of a breakage.

To 5.20

Requirement c) is e.g. fulfilled if:

- securing mechanisms such as snap-in latches or locking springs are fitted; or
- the distance that winding handles or levers up to a length of 250 mm can be pushed in their shafts is at least one-fifth of their own length.

To 7.4

The requirement "permanently fixed" is fulfilled, for example, if tools are required to fix and remove the nameplate. Stamped letters and numbers also fulfil this requirement.

Annex C (normative)

Design of rope drives

Feldfunktion geändert

Feldfunktion geändert

Feldfunktion geändert

The minimum rope diameter is determined by the following formula:

$$d = c \times \sqrt{\frac{F}{\eta_s}}$$

where

d is the minimum rope diameter, in millimetres;

c is a factor (see Table C.1);

F is the calculated traction force, in newtons;

η_s is the efficiency of the rope drive.

The efficiency of a rope drive, for calculation of the rope traction force is determined in accordance with the following formula:

$$\eta_s = (\eta_R)^i \times \eta_F = (\eta_R)^i \times \frac{1}{n} \times \frac{1 - (\eta_R)^n}{1 - \eta_R}$$

where

η_F is the efficiency of the pulley block;

$$\eta_F = \frac{1}{n} \times \frac{1 - (\eta_R)^n}{1 - \eta_R};$$

η_R is the efficiency of one pulley block;

$$\begin{aligned} \eta_R &= 0,96 \text{ for sliding bearings} \\ \eta_R &= 0,98 \text{ for anti friction bearings} \end{aligned}$$

i is the number of fixed pulleys between the rope, drum and the load;

n is the number of rope plies in one pulley block. One pulley block consists of the sum total of all the rope plies and rope pulleys for one rope winding onto a rope drum.

Table C.1 — Factor *c*

Nominal strength of the wires in newtons per square millimetre	1570	1770	1960
<i>c</i>	0,095	0,095	0,09

The pitch diameter of rope drums shall have at least 18 times the diameter of the rope.

The pitch diameter of rope pulleys shall have at least 20 times the diameter of the rope.

Annex D
(informative)**Example of information about wind**

Feldfunktion geändert

Feldfunktion geändert

Feldfunktion geändert

Table D.1 — Information about wind

Vehicle type	Empty weight t	Max. allowed wind speed m/s
Cars, caravans, long swap lorries	from 1 to 10	14
Bus, articulated lorries	from 10 to 15	20
Lorries and heavy vehicles	greater than 15	24

Annex E
(normative)

Protection against leakage

Feldfunktion geändert

Feldfunktion geändert

Feldfunktion geändert

Table E.1 — Protection against leakage

Drive system	EN 1493 Clause	Measure
(1) One cylinder	5.8.1 (Inadvertent motion)	(Pilot operated) non return valves ^a
	5.8.2 (Holding devices)	Pilot operated non return valves ^a or latches
	5.13.1 (Safety catch)	Not applicable (applies only to mechanical bearing devices)
	5.13.2 (Accompanying bearing devices)	Not applicable (applies only to mechanical bearing devices)
	5.14.1 (Limiting lowering speed)	Restrictor (max. 1,5 × lowering speed)
	5.14.2 (Protection against leakage)	Not applicable for hydraulic drives (latches are required in EN 1493, but the risk is considered to be low)
(2) Two independent cylinders	5.8.1 (Inadvertent motion)	(Pilot operated) non return valves ^a
	5.8.2 (Holding device)	(Pilot operated) non return valves ^a or latches
	5.13.1 (Safety catch)	Not applicable (applies only to mechanical bearing devices)
	5.13.2 (Accompanying bearing devices)	Not applicable (applies only to mechanical bearing devices)
	5.14.1 (Limiting lowering speed)	Restrictor (max. 1,5 × lowering speed)
	5.14.2 (Protection against leakage)	Two latches or total hydraulic redundancy per drive system
(3) Two cylinders Mechanically connected (each cylinder designed to carry the total load)	5.8.1 (Inadvertent motion)	(Pilot operated) non return valve ^a on each cylinder
	5.8.2 (Holding device)	(Pilot operated) non return valves ^a or latches
	5.13.1 (Safety catch)	Not applicable (applies only to mechanical bearing devices)
	5.13.2 (Accompanying bearing devices)	Not applicable (applies only to mechanical bearing devices)
	5.14.1 (Limiting lowering speed)	Restrictor (max. 1,5 × lowering speed)
	5.14.2 (Protection against leakage)	Pilot operated non return valve ^a on each cylinder (only one leakage considered)
(4) One cylinder + one rope/chain per suspension point	5.8.1 (Inadvertent motion)	(Pilot operated) non return valves ^a
	5.8.2 (Holding device)	Pilot operated non return valve ^a or latches
	5.13.1 (Safety catch)	Catching device (activated by an overspeed governor or chain/rope failure detector)

Drive system	EN 1493 Clause	Measure
	5.13.2 (Accompanying bearing devices)	Not used (applies only to two or more ropes/chains)
	5.14.1 (Limiting lowering speed)	Restrictor (max. 1,5 × lowering speed)
	5.14.2 (Protection against leakage)	Not applicable (latches are required in EN 1493, but the risk is considered to be low)
(5) One cylinder + two or more ropes/chains per suspension point	5.8.1 (Inadvertent motion)	(Pilot operated) non return valves ^a
	5.8.2 (Holding device)	Pilot operated non return valve ^a or latches
	5.13.1 (Safety catch)	Not used (because of 5.13.2)
	5.13.2 (Accompanying bearing devices)	rope/chain failure detector
	5.14.1 (Limiting lowering speed)	Restrictor (max. 1,5 × lowering speed)
	5.14.2 (Protection against leakage)	Not applicable (latches are required in EN 1493, but the risk is considered to be low)
(6) Spindle system(s) with safety catch	5.8.1 (Inadvertent motion)	Self braking system or additional brake
	5.8.2 (Holding device)	Self braking system or holding device
	5.13.1 (Safety catch)	Catching device
	5.13.2 (Accompanying bearing devices)	Not applicable
	5.14.1 (Limiting lowering speed)	Not applicable
	5.14.2 (Protection against leakage)	Not applicable
(7) Spindle system(s) with safety nut	5.8.1 (Inadvertent motion)	Self braking system or additional brake
	5.8.2 (Holding device)	Self braking system or holding device
	5.13.1 (Safety catch)	Not applicable
	5.13.2 (Accompanying bearing devices)	Safety nut
	5.14.1 (Limiting lowering speed)	Not applicable
	5.14.2 (Protection against leakage)	Not applicable

^a Valve, which is opened by force (hydraulic, pneumatic, electric) see 9.3.2.2.2 of ISO 1219-1:2006.

Definitions:**hydraulic and pneumatic circuit**

all components, such as pipes, hoses, relief valves, non return valves, cylinders and connections

leakage (it is assumed that only one leakage occurs in the circuit. The lowering of the vehicle will always be limited to 1,5 times the normal lowering speed.)

external or internal failure with any value of flow, e.g. external leakage: rupture of a hose

internal leakage: non return valve not properly closed or failure of cylinder seal

drive system

EN 1493:2010 (E)

unit for lifting the vehicle; a vehicle lift can be provided with one or more drive systems

holding device (see 5.8.2)

device, which holds the load bearing device automatically in its inoperative position by self locking means

catching device (see 3.14)

device, which holds the load carrying device in case of failure of the load bearing device

Annex F (normative)

Additional requirements for cableless controls and control systems

Feldfunktion geändert

Feldfunktion geändert

Feldfunktion geändert

F.1 Introduction

Cable-less controls shall be designed according to 9.2.7 of EN 60204-32:2008 with the following additions.

F.2 General

The cableless control station shall not send any moving command whilst the means to prevent unauthorised use is activated.

F.3 Control limitation

F.3.1 Activation of the cableless control station and the data communication shall be indicated on the cableless control station and shall not initiate any movement of the vehicle lift.

F.3.2 A moving command shall only be active when the receiver receives a correct message. For detailed requirements see F.5.

F.3.3 A moving command received by a message shall only be accepted if at least one correct message without any moving commands is received first.

F.3.4 To avoid inadvertent movements after any situation having caused the lift to stop (e.g. power supply fault, battery replacement or lost signal condition), the system shall only output operating commands resulting in any lift movement after the operator has returned the controls to "off" position for a suitable period of time, i.e. it has received at least one frame without any operating commands.

F.4 Stop

The part of the cableless control system to perform the emergency stop function is a safety related part of the lifts control system, as defined in 3.1.1 of EN ISO 13849-1:2008. This part of the cableless control system shall be designed to performance level d or higher according to EN ISO 13849-1:2008.

F.5 Serial data communication

F.5.1 When data communication is used in the implementation of a safety function then the residual error rate of the communication process shall be estimated taking into account transmission errors, repetitions, deletion, insertion, re-sequencing, corruption, delay and masquerade. This residual error rate shall be taken into account when estimating the performance level of the safety function due to random failures.

EN 1493:2010 (E)

Table F.1 shows the failures which shall be taken into consideration and corresponding safety measures.

Table F.1 — Failures and safety measures

Communication errors	Safety measures							
	Sequence number	Time stamp	Time expectation	Connection authentication	Feedback message	Data integrity assurance	Redundancy with cross checking	Different data integrity assurance systems
Corruption					X	X	Only for serial bus ^d	
Unintended repetition	X	X					X	
Incorrect sequence	X	X					X	
Loss	X				X		X	
Unacceptable delay		X	X ^c					
Insertion	X			X ^{a,b}	X ^a		X	
Masquerade				X ^a	X ^a			X
Addressing				X				
NOTE Table adapted from IEC 62280-2.								
<p>^a Depends on application.</p> <p>^b Only for sender identification. Detects only insertion of an invalid source.</p> <p>^c Required in all cases.</p> <p>^d This measure is only comparable with a high quality data assurance mechanism if a calculation can show that the residual error rate Λ reaches the values required in 5.4.9 when two messages are sent through independent transceivers.</p>								

F.5.2 There shall be a continuous data communication so that communication faults (e.g. deletion) are detected by the system.

F.5.3 The residual error rate is calculated from the residual error probability of the superimposed (safety) data integrity assurance mechanism and the transmission rate of safety messages. In addition, one shall take into account for the assessment the maximum number of information sinks (m) that is permitted in a single safety function.

Table F.2 — Relationship of residual error rate to performance level pl

Application for safety functions up to pl	Probability of a dangerous failure per hour for the functional safety communication system	Maximum permissible residual error rate for the functional safety communication system
e	$< 10^{-9} / \text{h}$	$\wedge < 10^{-9} / \text{h}$
d	$< 10^{-8} / \text{h}$	$\wedge < 10^{-8} / \text{h}$
b/c	$< 10^{-7} / \text{h}$	$\wedge < 10^{-7} / \text{h}$

NOTE Values in this table are based on the assumption that the functional safety communication system contributes no more than 1 % of the total failures of the safety function.

Equation (F.1) shown below shall be used to calculate the residual error rate resulting from RSL (Pe), unless the underlying model does not apply, or if another method may be more relevant. Items of the formula are specified in Table F.3.

$$\Lambda_{SL}(Pe) = RSL(Pe) \times v \times m \quad (\text{F.1})$$

NOTE This formula assumes cyclic transmission of safety messages.

Table F.3 — Formula items

Formula items	Definition
$\Lambda_{SL}(Pe)$	Residual error rate per hour of the safety communication layer with respect to the bit error probability.
Pe	Bit error probability. Unless a better error probability can be proven, a value of 10^{-2} shall be used.
$R_{SL}(Pe)$	Residual error probability of a safety message.
v	Maximum number of safety messages per hour.
m	Maximum number of information sinks that is permitted in a single safety function.

F.5.4 The control system shall initiate a stop of all lift movements when no valid frame has been correctly received within 1,0 s. The foreseen usage of the lift shall be tested to ensure that additional hazards do not result from this extension of the time value.

F.6 Use of more than one operator control station

F.6.1 Where a machine has more than one control station, measures shall be provided to ensure that initiation of commands from different control stations do not lead to a hazardous situation.

F.6.2 Means shall be provided to enable several transmitter/receiver pairs to operate in the transmission range without unwanted interference with each other.

F.6.3 The means provided in F.6.2 shall be protected from accidental or unintentional change.

F.7 Battery-powered operator control stations

A variation in the battery voltage shall not cause a hazardous situation. If one or more potentially hazardous motions are controlled using a battery-powered cableless operator control station, a clear warning shall be given to the operator when a variation in battery voltage exceeds specified limits. Under those circumstances, the cableless operator control station shall remain functional long enough for the operator to put the vehicle lift into a non-hazardous situation.

NOTE A time period of 10 min is normally acceptable.

F.8 Wireless control components

The wireless control components (transmitter and receiver) shall have sufficient mechanical strength against environmental influences and expected loads, such as vibration and bump.

NOTE See e.g. IEC 60068-2-6, IEC 60068-2-27, IEC 60068-2-75, IEC 60068-2-31.

Annex G
(normative)

Noise

Feldfunktion geändert

Feldfunktion geändert

Feldfunktion geändert

Generally noise is not considered to be a significant hazard for this type of machinery.

Therefore there is no special test method for noise in this standard.

This does not absolve the manufacturer of machines with a noise emission exceeding the criteria of the Machinery Directive of the responsibility to provide information about the noise emission in the information for use of the machine.

Any vehicle lift that produces a noise emission value of more than 70 dB(A) measured at 1,0 m from the major noise source shall have this measured value specified in the manual. If this value does not exceed 70 dB(A) this fact should be stated in the manual.

The operating conditions of the machine while under test and the test methods used to produce these figures should also be given in this manual.

Annex ZA
(informative)

Relationship between this European Standard and the Essential Requirements of EU Directive 2006/42/EC

This European Standard has been prepared under a mandate given to CEN by the European Commission and the European Free Trade Association to provide a means of conforming to Essential Requirements of the New Approach Directive 2006/42/EC.

Once this standard is cited in the Official Journal of the European Union under that Directive and has been implemented as a national standard in at least one Member State, compliance with the normative clauses of this standard confers, within the limits of the scope of this standard, a presumption of conformity with the relevant Essential Requirements of that Directive and associated EFTA regulations.

WARNING — Other requirements and other EU Directives may be applicable to the product(s) falling within the scope of this standard.

Bibliography

- [1] EN 10025-2:2004, *Hot rolled products of structural steels — Part 2: Technical delivery conditions for non-alloy structural steels*
- [2] EN 1760-2:2001+A1:2009, *Safety of machinery — Pressure sensitive protective devices — Part 2: General principles for the design and testing of pressure sensitive edges and pressure sensitive bars*